

# 2.4 GHz Digital Cordless Call Waiting Caller ID Compatible Multi-Handset System with Base and Handset Speakerphone User's Guide

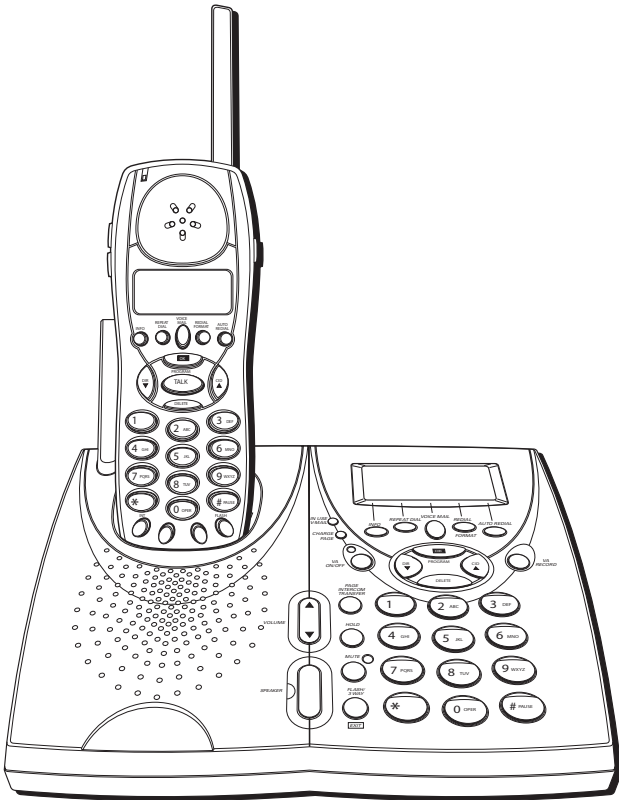

# EQUIPMENT APPROVAL INFORMATION

---

Your telephone equipment is approved for connection to the Public Switched Telephone Network and is in compliance with Parts 15 and 68, FCC Rules and Regulations and the Technical Requirements for Telephone Terminal Equipment published by ACTA.

## 1 Notification to the Local Telephone Company

On the bottom of this equipment is a label indicating, among other information, the US number and Ringer Equivalence Number (REN) for the equipment. You must, upon request, provide this information to your telephone company.

The REN is useful in determining the number of devices you may connect to your telephone line and still have all of these devices ring when your telephone number is called. In most (but not all) areas, the sum of the RENs of all devices connected to one line should not exceed 5. To be certain of the number of devices you may connect to your line as determined by the REN, you should contact your local telephone company.

A plug and jack used to connect this equipment to the premises wiring and telephone network must comply with the applicable FCC Part 68 rules and requirements adopted by the ACTA. A compliant telephone cord and modular plug is provided with this product. It is designed to be connected to a compatible modular jack that is also compliant. See installation instructions for details.

### Notes

- This equipment may not be used on coin service provided by the telephone company.
- Party lines are subject to state tariffs, and therefore, you may not be able to use your own telephone equipment if you are on a party line. Check with your local telephone company.
- Notice must be given to the telephone company upon permanent disconnection of your telephone from your line.
- If your home has specially wired alarm equipment connected to the telephone line, ensure the installation of this product does not disable your alarm equipment. If you have questions about what will disable alarm equipment, consult your telephone company or a qualified installer.

## 2 Rights of the Telephone Company

Should your equipment cause trouble on your line which may harm the telephone network, the telephone company shall, where practicable, notify you that temporary discontinuance of service may be required. Where prior notice is not practicable and the circumstances warrant such action, the telephone company may temporarily discontinue service immediately. In case of such temporary discontinuance, the telephone company must: (1) promptly notify you of such temporary discontinuance; (2) afford you the opportunity to correct the situation; and (3) inform you of your right to bring a complaint to the Commission pursuant to procedures set forth in Subpart E of Part 68, FCC Rules and Regulations.

The telephone company may make changes in its communications facilities, equipment, operations or procedures where such action is required in the operation of its business and not inconsistent with FCC Rules and Regulations. If these changes are expected to affect the use or performance of your telephone equipment, the telephone company must give you adequate notice, in writing, to allow you to maintain uninterrupted service.

## **INTERFERENCE INFORMATION**

This device complies with Part 15 of the FCC Rules. Operation is subject to the following two conditions: (1) This device may not cause harmful interference; and (2) This device must accept any interference received, including interference that may cause undesired operation.

This equipment has been tested and found to comply with the limits for a Class B digital device, pursuant to Part 15 of the FCC Rules. These limits are designed to provide reasonable protection against harmful interference in a residential installation.

This equipment generates, uses, and can radiate radio frequency energy and, if not installed and used in accordance with the instructions, may cause harmful interference to radio communications. However, there is no guarantee that interference will not occur in a particular installation.

If this equipment does cause harmful interference to radio or television reception, which can be determined by turning the equipment off and on, the user is encouraged to try to correct the interference by one or more of the following measures:

- Reorient or relocate the receiving antenna (that is, the antenna for radio or television that is "receiving" the interference).
- Reorient or relocate and increase the separation between the telecommunications equipment and receiving antenna.
- Connect the telecommunications equipment into an outlet on a circuit different from that to which the receiving antenna is connected.

If these measures do not eliminate the interference, please consult your dealer or an experienced radio/television technician for additional suggestions. Also, the Federal Communications Commission has prepared a helpful booklet, "How To Identify and Resolve Radio/TV Interference Problems." This booklet is available from the U.S. Government Printing Office, Washington, D.C. 20402. Please specify stock number 004-000-00345-4 when ordering copies.

## **FCC RF RADIATION EXPOSURE STATEMENT**

This equipment complies with FCC RF radiation exposure limits set forth for an uncontrolled environment. This equipment should be installed and operated with a minimum distance of 20 centimeters between the radiator and your body. This transmitter must not be co-located or operated in conjunction with any other antenna or transmitter.

For body worn operation, this phone has been tested and meets the FCC RF exposure guidelines when used with the belt clip supplied with this product. Use of other accessories may not ensure compliance with FCC RF exposure guidelines.

## **HEARING AID COMPATIBILITY (HAC)**

This telephone system meets FCC standards for Hearing Aid Compatibility.

US NUMBER IS LOCATED ON THE CABINET BOTTOM REN NUMBER IS LOCATED ON THE CABINET BOTTOM
-------------------------------------------------------------------------------------------



# TABLE OF CONTENTS

<b>EQUIPMENT APPROVAL INFORMATION</b> .....	2
<b>INTERFERENCE INFORMATION</b> .....	3
<b>FCC RF RADIATION EXPOSURE STATEMENT</b> .....	3
<b>HEARING AID COMPATIBILITY (HAC)</b> .....	3
<b>INTRODUCTION</b> .....	7
GETTING TO KNOW YOUR MULTI-HANSET CORDLESS SYSTEM .....	7
<b>HANSET LAYOUT</b> .....	9
<b>BASE LAYOUT</b> .....	9
HANDSET AND BASE BUTTONS .....	11
TELEPHONE COMPANY BUTTONS .....	11
HANDSET SIDE BUTTONS .....	12
BASE BUTTONS .....	12
<b>PARTS CHECKLIST</b> .....	12
TELEPHONE JACK REQUIREMENTS .....	12
<b>INSTALLATION</b> .....	12
IMPORTANT INSTALLATION GUIDELINES .....	13
INSTALLING THE PHONE .....	13
DATA PORT .....	14
<b>PROGRAMMABLE FUNCTIONS</b> .....	14
MENU MODE .....	15
LANGUAGE .....	15
INTERCOM RINGER .....	16
LINE RINGER .....	17
RINGER VOLUME .....	17
RINGER TYPE .....	18
LOCAL AREA CODE .....	19
REGIONAL AREA CODES .....	20
EDITING THE VOICE MAIL NUMBER .....	20
EDITING THE INFO SERVICE NUMBER .....	21
HOLD REMINDER/RINGER .....	22
RESETTING THE HANSET AND BASE TO THE FACTORY DEFAULT .....	23
DEREGISTRATION .....	24
HANSET .....	24
BASE .....	26
HANSET REGISTRATION .....	27
<b>ADDING HANSETS AND RE-INSTALLING THE SYSTEM</b> .....	29
ADDING ONE NEW HANSET TO THE SYSTEM .....	29
RE-INSTALLING THE SYSTEM .....	29
<b>BASIC OPERATION</b> .....	29
INITIALIZATION AND STANDBY MODE .....	29
INITIALIZATION MODE .....	29
BASE DISPLAY .....	30
LINKING THE HANSET TO THE BASE .....	30
MAKING EXTERNAL CALLS .....	30
ANSWERING CALLS .....	31
CALL TIMER .....	31
VOLUME .....	31
HANDSET RECEIVER VOLUME .....	31
HEADSET VOLUME .....	32
HANDSET SPEAKERPHONE VOLUME .....	32
BASE SPEAKERPHONE VOLUME .....	32
SPEAKERPHONE OPERATION .....	32
MAKING CALLS WITH THE SPEAKERPHONE .....	32
ANSWERING CALLS WITH THE SPEAKERPHONE .....	32
HEADSET .....	33
REDIAL .....	33

REDIAL PREVIEW DIALING.....	34
HOLD.....	34
HOLD REMINDER.....	34
HOLD RECALL RINGER .....	34
INTERCOM.....	35
MAKING INTERCOM CALLS.....	35
HANDSET.....	35
BASE .....	37
ANSWERING INTERCOM CALLS.....	37
USING INTERCOM WITH EXTERNAL CALLS .....	38
RECEIVING AN INCOMING TELEPHONE CALL DURING AN INTERCOM CALL.....	39
TRANSFERRING A CALL .....	39
TRANSFERRING AN OUTSIDE CALL THROUGH INTERCOM .....	40
CONFERENCE CALLS .....	40
CONFERENCING WITH AN EXTERNAL CALL AND INTERCOM .....	40
DIRECTORY MEMORY .....	41
STORING NAMES AND NUMBERS IN MEMORY.....	41
RECORDING VOICE ANNOUNCEMENT ON THE BASE.....	43
EDITING NAMES AND NUMBERS FROM MEMORY .....	44
REVIEWING AND DELETING NAMES AND NUMBERS FROM DIRECTORY .....	45
DIALING A NUMBER FROM DIRECTORY .....	46
DIALING AFTER PICKING UP THE LINE .....	47
CHAIN DIALING FROM DIRECTORY MEMORY .....	47
<b>CALL WAITING CALLER ID (CID) .....</b>	<b>48</b>
CALLER ID (CID) DATABASE .....	48
CALLER ID DISPLAY SCREEN.....	49
CALLER ID INFORMATION VOICE ANNOUNCEMENT (FOR CALLER ID TYPE 1 ONLY).....	49
REVIEWING CID RECORDS.....	49
DELETING A CID RECORD .....	50
DELETING ALL CID RECORDS FROM THE CID DATABASE .....	51
DIALING A CID RECORD.....	51
TRANSFERRING A CID RECORD TO DIRECTORY MEMORY.....	52
<b>CALL WAITING CALLER ID DELUXE .....</b>	<b>54</b>
CALLER ID TYPE 2.5 FUNCTIONS.....	55
BUSY.....	55
CONFERENCE.....	56
VOICE MAIL .....	56
PLEASE HOLD.....	57
RETURN THE OTHER CALL .....	57
BUILD THE CONFERENCE CALL.....	58
DROP THE LAST CALL.....	58
DROP.....	58
ANSWER.....	59
<b>DISPLAY MESSAGES .....</b>	<b>60</b>
<b>SPECIAL FEATURES .....</b>	<b>61</b>
CHARGE/PAGE INDICATOR .....	61
IN USE/V-MAIL INDICATOR .....	61
MESSAGE WAITING .....	61
PAGING ALL HANDSETS .....	61
FLASH.....	62
PAUSE .....	62
MUTING YOUR CONVERSATION .....	63
OUT OF RANGE WARNING.....	63

BATTERY LOW WARNING.....	63
3-WAY CONFERENCE (FLASH 3-WAY EXIT).....	63
TELEPHONE COMPANY SERVICE BUTTONS .....	63
VOICE MAIL BUTTON.....	63
INFO BUTTON.....	64
REPEAT DIAL BUTTON.....	64
AUTO REDIAL BUTTON.....	64
TELEPHONE COMPANY SERVICES LIMITATIONS .....	65
<b>REPLACING THE BATTERY .....</b>	<b>65</b>
BATTERY SAFETY INSTRUCTIONS .....	65
<b>TROUBLESHOOTING TIPS .....</b>	<b>66</b>
TELEPHONE SOLUTIONS .....	66
CALLER ID SOLUTIONS .....	67
BATTERY SOLUTIONS .....	67
<b>GENERAL PRODUCT CARE.....</b>	<b>67</b>
<b>CAUSES OF POOR RECEPTION.....</b>	<b>68</b>
<b>SERVICE .....</b>	<b>68</b>
<b>INDEX .....</b>	<b>69</b>
<b>LIMITED WARRANTY.....</b>	<b>72</b>

**WARNING:** TO PREVENT FIRE OR ELECTRICAL SHOCK HAZARD, DO NOT EXPOSE THIS PRODUCT TO RAIN OR MOISTURE.

	<p><b>CAUTION:</b> RISK OF ELECTRIC SHOCK DO NOT OPEN</p>	
<p>THE LIGHTNING FLASH AND ARROW HEAD WITHIN THE TRIANGLE IS A WARNING SIGN ALERTING YOU OF "DANGEROUS VOLTAGE" INSIDE THE PRODUCT.</p>	<p>CAUTION: TO REDUCE THE RISK OF ELECTRIC SHOCK, DO NOT REMOVE COVER (OR BACK). NO USER SERVICEABLE PARTS INSIDE. REFER SERVICING TO QUALIFIED SERVICE PERSONNEL.</p>	<p>THE EXCLAMATION POINT WITHIN THE TRIANGLE IS A WARNING SIGN ALERTING YOU OF IMPORTANT INSTRUCTIONS ACCOMPANYING THE PRODUCT.</p>
<p>SEE MARKING ON BOTTOM / BACK OF PRODUCT</p>		

# INTRODUCTION

---

## GETTING TO KNOW YOUR MULTI-HANSET CORDLESS SYSTEM



**CAUTION: When using telephone equipment, there are basic safety instructions that should always be followed. Refer to the IMPORTANT SAFETY INSTRUCTIONS provided with this product and save them for future reference.**

Congratulations on purchasing this Multi-handset Telephone System. This system operates in the 2.4 GHz frequencies and is unique to conventional cordless telephones. When the base is connected to electrical power and a telephone line, it can support up to four handsets, and you can place an extra handset in the same location anywhere where electrical power is available. The system provides one outside line and one intercom path. And, the base unit provides four voice channels for four handset users to perform intercom and outside calls at the same time. You can also easily use your multi-handset system to quickly access your telephone company's convenient features with one touch of the direct access buttons on your handset.

### Features:

- 2.4 GHz Digital Cordless Multi-Handset Technology
- Speakerphone on Base and Handset
- Handset to Handset and Handset to Base Intercom
- 3-way Conference/Call Transfer
- Call Waiting and Caller ID Compatible
- Caller ID Voice Announcement on Base (User Recordable)
- Pre-Dialing (up to 30 digits)
- Most Frequently Used Names and Numbers Memory Dialing
- ENREV Battery Charging Technology, which optimizes battery charging and improves battery life
- Voice Message Waiting Indicator
- Telephone Company Direct Access Buttons

This telephone has been designed to be simple to use, however, you can reach its full potential more quickly by taking a few minutes to read this instruction book. This telephone is a multifunction product for use with Call Waiting Caller ID services and special telephone company features available from your local telephone company.

### **Your Call Waiting Caller ID phone allows you to:**

- View the name and telephone number of a caller (Call Waiting Caller ID).
- Identify callers before you answer the phone.
- View the time and date of each incoming call.
- Record up to 50 Caller ID messages sequentially.
- Know who called while you are on the line or when you were away.
- Screen unwanted calls, eliminate harassment from annoying calls, or to get prepared before answering a call.
- Caller ID Multi-function: Busy, Conference, To Voice Mail, Please Hold, Drop, Answer.

### **Telephone company direct access buttons allow you to:**

- Directly access your voice mail with one touch of the VOICE MAIL button.
- Directly access your info service with one touch of the INFO button.
- Repeatedly dial a busy number with one touch of the REPEAT DIAL button.
- Automatically and repeatedly redial a number with one touch of the AUTO REDIAL button.

**IMPORTANT: Because cordless phones operate on electricity, you should have at least one phone in your home that isn't cordless, in case the power in your home goes out.**

**IMPORTANT: In order to use all of the features of this telephone, you must subscribe to two separate services available from your local telephone company: the standard Name/Number Caller ID Service to know who is calling when the phone rings and Call Waiting Caller ID Service to know who is calling while you are on the phone.**

**INSTALLATION NOTE: Some cordless telephones operate at frequencies that may cause interference to nearby TVs, microwave ovens, and VCRs. To minimize or prevent such interference, the base of the cordless telephone should not be placed near or on top of a TV, microwave ovens, or VCR. If such interference continues, move the cordless telephone farther away from these appliances. Certain other communications devices may also use the 2.4 GHz frequency for communication, and, if not properly set, these devices may interfere with each other and/or your new telephone. If you are concerned with interference, please refer to the owner's manual for these devices on how to properly set channels to avoid interference. Typical devices that may use the 2.4 GHz frequency for communication include wireless audio/video senders, wireless computer networks, multi-handset cordless telephone systems, and some long-range cordless telephone systems.**



# HANDSET LAYOUT

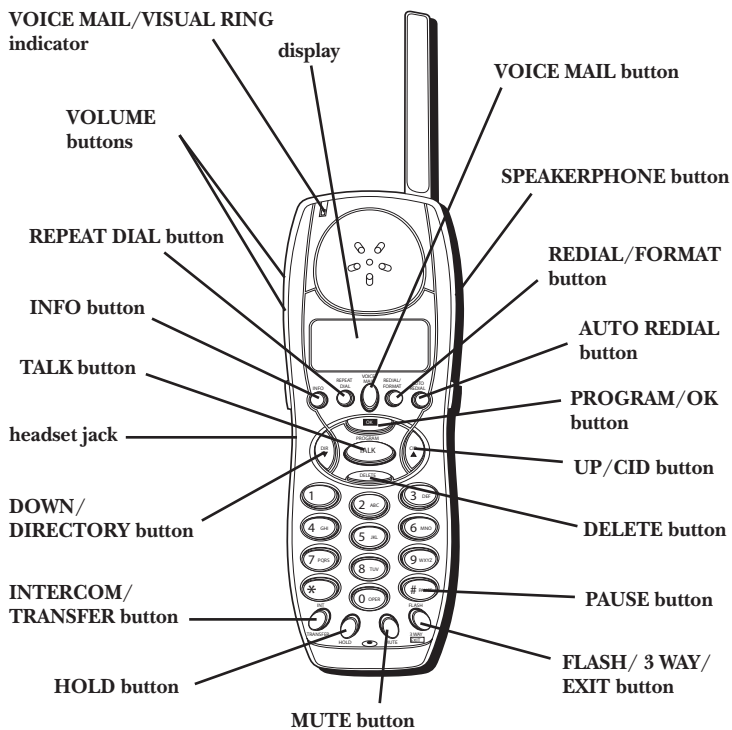

# BASE LAYOUT

Back Side

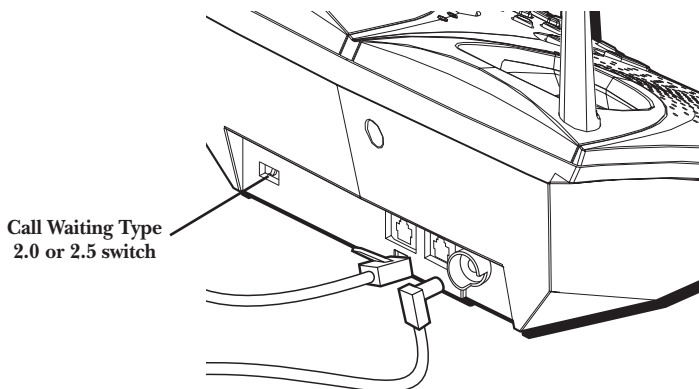

**IN USE V-MAIL/visual ring indicator**

**CHARGE PAGE/registration mode indicator**

**voice announcement ON/OFF indicator**

**voice announcement ON/OFF button**

**OK/PROGRAM button**

**VOICE MAIL button**

**REPEAT DIAL button**

**DOWN/DIRECTORY button**

**REDIAL/FORMAT button**

**UP/CID button**

**AUTO REDIAL button**

**INFO button**

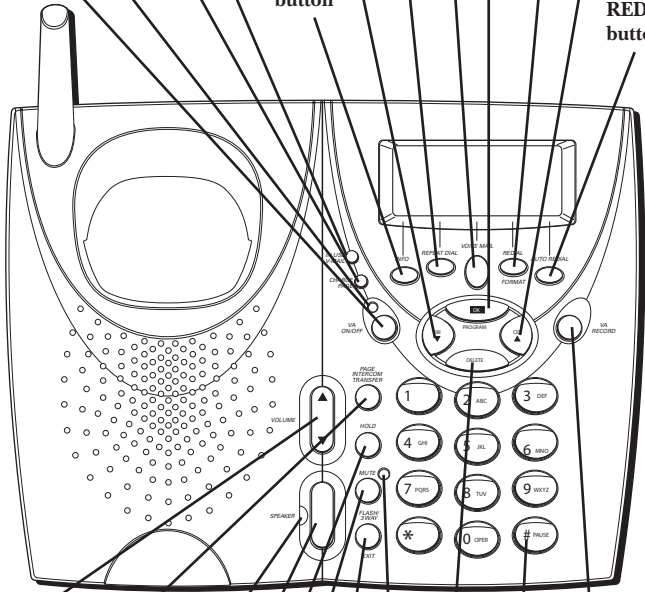

**VOLUME button**

**PAGE/INTERCOM/TRANSFER button**

**SPEAKER indicator**

**SPEAKER button**

**HOLD button**

**MUTE button**

**FLASH/3 WAY/EXIT button**

**MUTE indicator**

**DELETE button**

**PAUSE button**

**voice announcement RECORD button**

## HANDSET AND BASE BUTTONS

<b>NUMBER/ TOUCH TONE PAD</b>	Dials numbers and enters.
<b>TALK - handset</b>	Starts external calls, answers calls, and ends calls.
<b>SPEAKER - base</b>	Starts external calls, answers calls, and ends calls.
<b>FLASH</b>	Activates special phone company services such as call waiting.
<b>EXIT</b>	Exits programming, directory, or Caller ID mode.
<b>MUTE</b>	Turns the handset and base microphone off so that the party on the other end of the line cannot hear any conversation.
<b>REDIAL</b>	Redials last number dialed.
<b>PAUSE</b>	Inserts a time delay (pause) in the number dialing sequence.
<b>HOLD</b>	Places an outside call on hold.
<b>TRANSFER</b>	Transfers an active call to another handset.
<b>INTERCOM</b>	Makes an intercom call to another handset, or base, and picks up or disconnects an intercom call.
<b>PROGRAM</b>	Enters the programming mode.
<b>OK</b>	Confirms selection of a programmable item.
<b>DIRECTORY</b>	Accesses the Directory.
<b>CID</b>	Enters the Caller ID database.
<b>UP, DOWN</b>	Scrolls or moves cursor in display while in programming mode or reviewing Caller ID records or Directory.
<b>DELETE</b>	Deletes text or information.
<b>FORMAT</b>	Formats the call back number with or without area code or selects the phone book name/determines how number shows in display.
<b>3 WAY</b>	Activates conference with two external parties.

## TELEPHONE COMPANY BUTTONS

<b>INFO</b>	Accesses your telephone company's information services number.
<b>REPEAT DIAL</b>	Repeatedly redials a busy number.
<b>VOICE MAIL</b>	Accesses your telephone company's voice mail service.
<b>AUTO REDIAL</b>	Automatically redials a number.

## HANDSET SIDE BUTTONS

- VOLUME** Adjusts receiver, headset, and speakerphone volume level.
- SPEAKER** Accesses handset speakerphone.

## BASE BUTTONS

- PAGE** Triggers a page ringer on cordless handset; helps locate a misplaced handset.
- VA RECORD** Starts recording your Caller ID Voice Announcement.
- VA ON/OFF** Turns on or off your Caller ID Voice Announcement.
- VOLUME** Adjusts Caller ID voice announcement and speakerphone volume level.

## PARTS CHECKLIST

Make sure your package includes the items shown here.

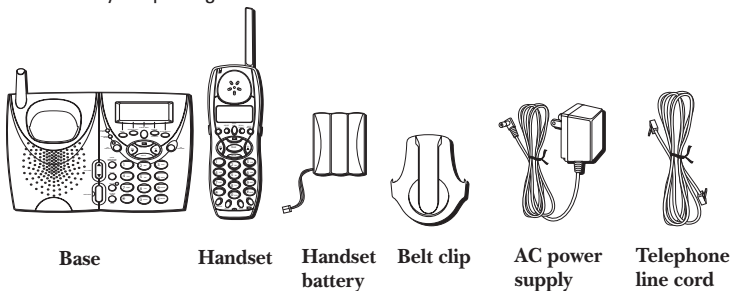

## TELEPHONE JACK REQUIREMENTS

To use this phone, you need an RJ11C type modular telephone jack, which might look like the one pictured here, installed in your home. If you don't have a modular jack, call your local phone company to find out how to get one installed.

Modular telephone line jack

Wall plate

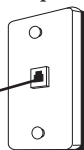

**NOTE: If you need an additional handset for this multi-handset system, you may purchase model H1115.**

## INSTALLATION

- Never install telephone wiring during a lightning storm.
- Never install telephone jacks in wet locations unless the jack is specifically designed for wet locations.
- Never touch non-insulated telephone wires or terminals, unless the telephone line has been disconnected at the network interface.
- Use caution when installing or modifying telephone lines.
- Temporarily disconnect any equipment connected to the phone such as faxes, other phones, or modems.

## IMPORTANT INSTALLATION GUIDELINES

- Install telephone near both a telephone (modular) jack and an electrical power outlet.
- Avoid sources of noise, such as a window by a busy street, and electrical noise, such motors, microwave ovens, and fluorescent lighting.
- Avoid heat sources, such as heating air ducts, heating appliances, radiators, and direct sunlight.
- Avoid areas of excessive moisture or extremely low temperature.
- Avoid dusty locations.
- Avoid other cordless telephones or personal computers.

## INSTALLING THE PHONE

1. Choose an area near an electrical outlet and a telephone wall jack (RJ11C), and place your cordless telephone on a level surface, such as a desk or tabletop.
2. Plug the AC power supply into the electrical outlet and the DC connector into the jack marked POWER/9VDC on the back of the base.



**CAUTION: Use only the ATLINKS USA, Inc. power supply 5-2572 that came with this unit. Using other power supplies may damage the unit.**

**NOTE: Additional handsets include their own charging cradles.**

3. Install the handset battery.



**CAUTION: To reduce the risk of fire or personal injury, use only the battery, 5-2569, which is compatible with this unit.**

**NOTE: You must connect the handset battery before use.**

- Remove the battery cover located on the back of the handset by pressing on the indent and sliding downward.
- Plug the battery pack cord into the jack located inside the battery

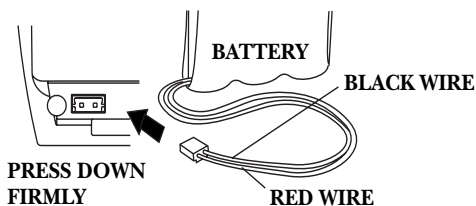

compartment, then place the battery pack inside the battery compartment.

**NOTE: It is important to maintain the polarity (black and red wires) to the jack inside the compartment as shown in the illustration.**

- Slide the battery compartment cover back into place.
4. Place the handset in the charge cradle. The charge/page indicator turns on to indicate the battery is charging.
  5. Allow the handset to charge, for 6 hours prior to first use. If you don't properly charge the handset, battery performance is compromised.

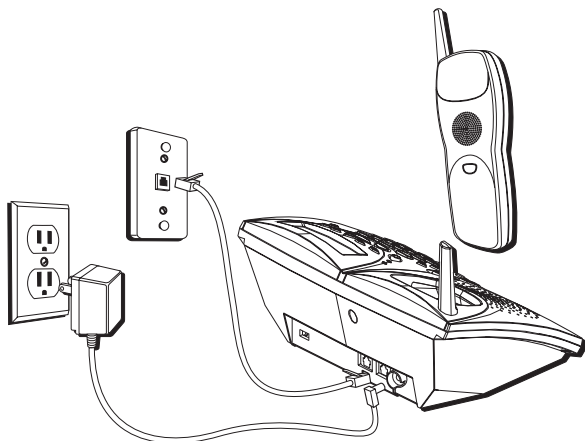

6. After the handset is properly charged, connect the telephone line cord by plugging one end of the line into the jack on the back of the base marked TEL LINE and the other end into a telephone wall jack.
7. Attach the belt clip. Align the tabs on the inside edges of the belt clip with the slots on each side of the handset and snap the belt clip into place.

**NOTE: Only the base needs a phone line connection. Extra cordless handsets with charge cradles can be installed anywhere electrical power is available.**

## DATA PORT

This phone is equipped with a data port jack labeled DATA on the back of the base unit for you to connect an auxiliary phone device, such as a fax machine, computer modem, or answering system.

## PROGRAMMABLE FUNCTIONS

There are several different menus available on the handset and base, which are programmable through the display box: *LANGUAGE, INTERCOM RING, LINE RING, RING VOLUME, RINGTYPE, AREA CODE, VOICE MAIL, INFO SERVICE, HOLD REMINDER, RESET, DE-REGISTER, and REGISTRATION.*

The table below shows the programmable items.

*Programmable Items*    *Choices (factory default settings marked with \*)*

LANGUAGE	ENGLISH*/FRENCH/SPANISH	
INTERCOM RING	ON*/OFF	
LINE RING	ON*/OFF	
RINGER VOLUME	HIGH/MIDDLE*/LOW	
RINGERTYPE	1*/2/3/4	
AREA CODE	LOCAL CODE	:EMPTY* (3 Digits)
	REGIONAL CODES (1-6)	:EMPTY* (3 Digits each)
VOICE MAIL	EMPTY*	
INFO SERVICE	411*	

HOLD REMINDER	OFF/15/30*/45/60 (seconds)
RESET	YES ?/NO?
DE-REGISTER	Base: HANDSET #1, 2, 3, 4, ALL Handset: YES ?/NO?
REGISTRATION	YES ?/NO?

---

## MENU MODE

Use the Menu Mode to customize your multi-handset system to meet your needs. You must be in the Menu Mode to program your multi-handset system.

**NOTE: The settings for the base and handset are identical, except for RESET and REGISTRATION.**

Make sure your phone is OFF (not in TALK mode).

1. Press the PROGRAM/OK button to enter the menu mode.
2. Use the ▲ or ▼ button on the handset to scroll to the menu item you want to program.

**NOTE: When you first enter the menu mode, the arrow in the display points to LANGUAGE. Use the ▲ button to move forward and the ▼ button to move backward. For example, if you press the ▲ button, the arrow in the display moves to REGISTRATION. If you press the ▼ button, the arrow in the display points to INTERCOM RING.**



```
>LANGUAGE
INTERCOM RING
```

3. Press the PROGRAM/OK button to confirm and save your selection, or press the ▲ or ▼ button to select other programmable items.

**NOTE: You may press the FLASH/3 WAY/EXIT button to immediately exit the menu mode, or if you don't press a button within 30 seconds the system automatically exits the menu mode.**

## LANGUAGE

This setting, allows you to display messages or instructions in English, French, or Spanish. English is the default setting.

1. Make sure your phone is OFF (not in TALK mode).
2. Press the PROGRAM/OK button to enter the menu mode. The display shows:



```
>LANGUAGE
INTERCOM RING
```

3. Press the PROGRAM/OK button to select the desired language setting. The display shows:



4. Press ▲ or ▼ button to change the language selection.
5. Press the PROGRAM/OK button to confirm and save your selection. The display shows:

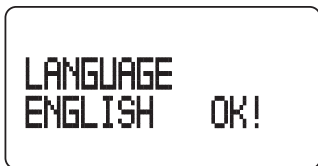

**NOTE: The unit generates a confirmation beep when the setting is OK.**

After three seconds, the display returns to the main menu to program the other items. The display shows:



## **INTERCOM RINGER**

1. Make sure your phone is OFF (not in TALK mode).
2. Press the PROGRAM/OK button to enter the menu mode.
3. Press the ▲ or ▼ button until the arrow in the display points to *INTERCOM RING*. Press the PROGRAM/OK button to go to *INTERCOM RING* setting. The default setting is *ON*.



4. Press the ▲ or ▼ button to change the setting.



5. Press the PROGRAM/OK button to confirm and save your selection. The display shows:



**NOTE: Press the FLASH/3 WAY/EXIT button to keep the previous setting and return to the main menu. If you don't press a button within 30 seconds, the system automatically exits the menu mode.**

## LINE RINGER

1. Make sure your phone is OFF (not in TALK mode).
2. Press the PROGRAM/OK button to enter the menu mode.
3. Press the ▲ or ▼ button until the arrow in the display points to *LINE RING*.
4. Press the PROGRAM/OK button to go to *LINE RING*. The default setting is *ON*.



5. Press the ▲ or ▼ button to change the setting.
6. Press the PROGRAM/OK button to confirm and save your selection. The display shows:

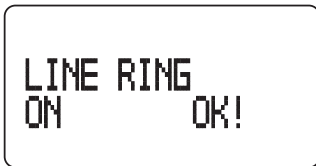

**NOTE: Press the FLASH/3 WAY/EXIT button to keep the previous setting and return to the main menu. If you don't press a button within 30 seconds, the system automatically exits the menu.**

## RINGER VOLUME

1. You can program the desired ringer volume.
2. Make sure your phone is OFF (not in TALK mode).
3. Press the PROGRAM/OK button to enter the menu mode.
4. Press the ▲ or ▼ button until the arrow in the display points to *RING VOLUME*.
5. Press the PROGRAM/OK button to go to *RING VOLUME*. The default setting is *MIDDLE*.



RING VOLUME  
MIDDLE

6. Press the ▲ or ▼ button to scroll to your selection. The choices are: high, middle, and low.

**NOTE: The handset or base generates a ring when you make your selection.**

7. Press the PROGRAM/OK button to confirm and save your selection. The display shows:



RING VOLUME  
HIGH OK!

**NOTE: Press the FLASH/3 WAY/EXIT button to keep the previous setting and return to the main menu. If you don't press a button within 30 seconds, the system automatically exits the menu mode.**

## RINGER TYPE

1. Make sure your phone is OFF (not in TALK mode).
2. Press the PROGRAM/OK button to enter the menu mode.
3. Press the ▲ or ▼ button until the arrow in the display points to *RINGTYPE*.
4. Press the PROGRAM/OK button to go to *RINGTYPE*. The default setting is 1.



RING TYPE  
1

5. Press the ▲ or ▼ button to select 1, 2, 3 or 4.

**NOTE: The handset or base generates the ring type you select.**

6. Press the PROGRAM/OK button to confirm and save your selection. The display shows:



RING TYPE  
3 OK!

**NOTE: Press the FLASH/3 WAY/EXIT button to keep the previous setting and return to the main menu. If you don't press a button within 30 seconds, the system automatically exits the menu mode.**

## LOCAL AREA CODE

The telephone uses the programmed area codes to determine the number format to display when a valid Caller ID signal is received. If you enter your local 3-digit area code, Caller ID messages received from your local area will be displayed as a seven digit number. Entering your local area code will also help you immediately know if the call is local or long distance when viewing the CID records in the display. Call records received from outside of your local area code appear as full ten-digit numbers.

You may set one 3-digit local area code. Do not use the \* or # characters. Each code must only be three digits long. If you enter more or less than three digits, you will hear a warning beep.

1. Make sure your phone is OFF (not in TALK mode).
2. Press the PROGRAM/OK button to enter the menu mode.
3. Press the ▲ or ▼ button until the arrow in the display points to *AREA CODE*.
4. Press the PROGRAM/OK button to enter the *AREA CODE* menu.  
The display shows:



>LOCAL CODE  
REGIONAL CODE1

5. Press the PROG/OK button to go to *LOCAL CODE*. The default is *EMPTY*.



LOCAL CODE  
EMPTY

6. Enter your three-digit area code. For example, if you live in Los Angeles, you should enter:



LOCAL CODE  
213

7. Press the PROGRAM/OK button to confirm and save your selection. The display shows:

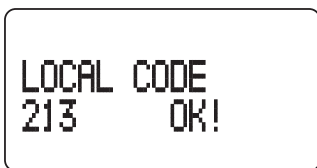

## REGIONAL AREA CODES

You may set up to six 3-digit regional area codes. Each code must only be three digits long. Do not use the \* or # characters. If you enter more or less than three digits, you will hear a warning beep.

1. Make sure your phone is OFF (not in TALK mode).
2. Press the PROGRAM/OK button to enter the menu mode.
3. Press the ▲ or ▼ button until the arrow in the display points to *AREA CODE*. Press the PROGRAM/OK button to enter the *AREA CODE* menu.
4. Press the ▲ or ▼ button until the arrow in the display points to *REGIONAL CODE 1*.
5. Press the PROGRAM/OK button to go to *REGIONAL CODE 1*. The default setting is *EMPTY*.
6. Enter your first 3-digit regional area code.
7. Press PROGRAM/OK button to confirm and save your selection.
8. Repeat steps 4 to 7 for REGIONAL CODE 2 to 6.

**NOTE: To delete a previously entered Local Area or Regional Code press the DELETE button.**

## EDITING THE VOICE MAIL NUMBER

1. Make sure your phone is OFF (not in TALK mode).
2. Press the PROGRAM/OK button to enter the menu mode.
3. Press the ▲ or ▼ button until the arrow in the display points to *VOICE MAIL*.
4. Press the PROGRAM/OK button to go to *VOICE MAIL* number editing. The default setting is *EMPTY*.
5. Use the touch tone pad on the handset to enter the voice mail number (up to 20 digits, for example, 3155551324).



**NOTE: If you enter over 14 digits, the display shows the last 14 digits. If you try to enter more than 20 digits, you will hear a warning beep.**

**NOTE: If you program your voice mail access password into the voice mail number string, you may use the #/PAUSE button to insert a delay prior to voice mail password entry by pressing the #/PAUSE button twice. A pause displays as "P." You may add more than one pause if a longer delay is needed in the dialing sequence.**



VOICE MAIL  
3155551324

6. Press the PROGRAM/OK button to confirm and save your selection. The display shows:



VOICE MAIL  
3155551324 OK!

**NOTE: Each handset may have a different voice mail number.**

To delete a voice mail number, press the DELETE button twice. The display shows:



VOICE MAIL  
DELETE?

**FIRST DISPLAY SCREEN**



VOICE MAIL  
EMPTY OK!

**SECOND DISPLAY SCREEN**

## **EDITING THE INFO SERVICE NUMBER**

1. Make sure your phone is OFF (not in TALK mode).
2. Press the PROGRAM/OK button to enter the menu mode.
3. Press the  $\blacktriangle$  or  $\blacktriangledown$  button until the arrow in the display points to *INFO SERVICE*.
4. Press the PROGRAM/OK button to go to *INFO SERVICE* code editing. The default setting is 411.



INFO SERVICE  
411

5. Enter your info service code (up to 11 digits, for example, 3155551324).

**NOTE: If you enter more than 11 digits, you will hear a warning beep.**



INFO SERVICE  
3155551324

6. Press the PROGRAM/OK button to confirm and save your selection. The display shows:



INFO SERVICE  
3155551324 OK!

**NOTE: Each handset may have a different info service number.**

To delete the info service number, press the DELETE button twice. The display shows:



INFO SERVICE  
DELETE?

FIRST DISPLAY SCREEN



INFO SERVICE  
411 OK!

SECOND DISPLAY SCREEN

**NOTE: When your info service code is deleted, the system automatically returns to the default setting of 411.**

**NOTE: If you do not want to delete the info service number, press the EXIT button to return to INFO SERVICE edit mode.**

## **HOLD REMINDER/RINGER**

When an outside line is on hold, Hold Reminder makes the system wait for a predetermined period of time before it generates a triple-beep reminder. Choices for length of wait time are: Off/15/30/45/60 Seconds. The default setting is 30 seconds.

1. Make sure your phone is OFF (not in TALK mode).
2. Press the PROGRAM/OK button to enter the menu mode.
3. Press the ▲ or ▼ button until the arrow in the display points to the *HOLD REMINDER*.

4. Press the PROGRAM/OK button to go to *HOLD REMINDER*. The default setting is 30 seconds.



5. Press the ▲ or ▼ button to select 15, 30, 45, 60 seconds or OFF. For example, to select 45 seconds move the arrow to 45. The display shows:



6. Press the PROGRAM/OK button to confirm and save your selection. The display shows:

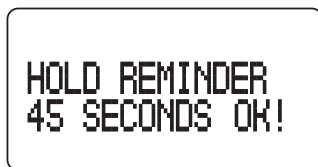

**NOTE: If you choose OFF, you will turn off the reminder beeps.**

**NOTE: Press the 3 WAY/EXIT button to keep the previous setting and return to the main menu screen.**

**NOTE: If you don't press a button within 30 seconds, the system automatically exits the menu mode.**

## **RESETTING THE HANDSET AND BASE TO THE FACTORY DEFAULT**

Once you become familiar with your multi-handset system, you may prefer to use the original settings. Resetting to the factory default sets all information on the unit back to the factory default, except the Caller ID database, directory, handset ID, and registration information.

1. Make sure your phone is OFF (not in TALK mode).
2. Press the PROGRAM/OK button to enter the menu mode.
3. Press the ▲ or ▼ button until the arrow in the display points to *RESET BASE* or *RESET HANDSET*.

4. Press PROGRAM/OK button to go to *RESET BASE* or *RESET HANDSET*. The display shows:

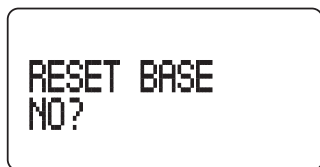

**BASE**



**HANDSET**

5. Press the ▲ or ▼ button to select *YES?*.

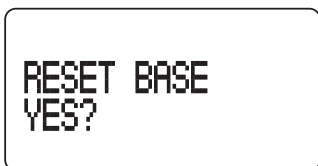

**BASE**



**HANDSET**

**NOTE: Select YES to reset to the factory default settings, or select NO to exit.**

6. Press the PROGRAM/OK to confirm and save your selection. The display shows:



**NOTE: After three seconds, the handset or base returns to the default settings. The display shows the following message for 5 – 10 seconds:**

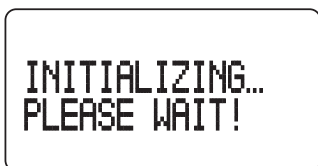

## **DEREGISTRATION**

### **HANDSET**

If you are not going to use the handset or you want to register it to another base, you must cancel the original registration.

1. Make sure the phone is OFF (not in TALK mode).
2. Press the PROGRAM/OK button to enter the menu mode.



3. Press the ▲ or ▼ button until the arrow in the display points to the *DE-REGISTER*.
4. Press the PROGRAM/OK button to go to *DE-REGISTER*. The display shows:

DE-REGISTER  
NO?

5. Press the ▲ or ▼ button to move the arrow in the display to *YES?*

DE-REGISTER  
YES?

**NOTE: Select YES to de-register, or NO to exit.**

6. Press the PROGRAM/OK button to confirm your selection. The display shows:
7. Place the handset on the base cradle.

DE-REGISTER PUT  
HANDSET IN BASE

If de-registration is successful, the display shows:

If the de-registration fails, after 15 seconds, the handset shows:

DE-REGISTER  
OK!

FAILED  
TRY AGAIN!

**NOTE: The base doesn't need to be in DE-REGISTER mode while the handset is de-registered.**

**NOTE: You must place the handset on the base cradle during de-registration.**

**NOTE: A handset may register to another base without de-registering via the original base. But the original base, however, will keep the handset's registration information.**

## BASE

To de-register all handsets or remove one handset, use the base. The handset must be kept near the base during the de-registration process. After de-registration, handsets will no longer link to the base any more.

1. Make sure the phone is OFF (Not in TALK mode).
2. Press the PROGRAM/OK button to enter the menu mode.
3. Press the ▲ or ▼ button until the arrow in the display points to *DE-REGISTER*.
4. Press the PROGRAM/OK button to go to *DE-REGISTER*. The display will show:



DE-REGISTER  
HANDSET #1?

5. Press the ▲ or ▼ button to select an individual handset or all handsets. For example, if you select *ALL HANDSETS*, the display shows:



DE-REGISTER  
ALL HANDSETS?

6. Press the PROGRAM/OK button to confirm your selection. The display shows:



DE-REGISTER  
PLEASE WAIT!

After de-registration, the display shows:

A rectangular display box with a black border containing the text "DE-REGISTER ALL HANDSET OK!" in a pixelated, monospace font.

**NOTE: It takes a few seconds for each handset to deregister (approximately 3 to 10 seconds). The more handsets you want to deregister at one time, the longer the deregistration process takes.**

**NOTE: Occasionally, the de-registration process finishes very quickly and the message DE-REGISTER PLEASE WAIT! may not appear.**

## HANDSET REGISTRATION

Registration links the base to a cordless handset. Once a handset is registered it can use the base's phone connection. A cordless handset will not operate until it is registered to the base.

### On the base unit:

1. Make sure your phone is OFF (not in TALK mode).
2. Press the PROGRAM/OK button to enter the menu mode.
3. Press the ▲ or ▼ button until the arrow in the display points to *REGISTRATION*.
4. Press PROGRAM/OK button and the display shows:

A rectangular display box with a black border containing the text "REGISTRATION NO?" in a pixelated, monospace font.

5. Press the ▲ or ▼ button to select YES?

A rectangular display box with a black border containing the text "REGISTRATION YES?" in a pixelated, monospace font.

**NOTE: Select YES to register the handset, or NO to exit.**

6. Press the PROGRAM/OK button to confirm. The base display shows:

A rectangular display box with a black border containing the text "REGISTRATION MODE" in a pixelated, monospace font.

**NOTE:** REGISTRATION MODE shows in the display for 30 seconds, and the CHARGE/PAGE indicator flashes slowly.

**TIP:** If the handset display shows PLEASE REGISTER! or TO REGISTER PUT HANDSET IN BASE, handset is ready for registration. You may skip steps 7 through 10 for the handset.

**On the handset:**

7. Press the PROGRAM/OK button to enter the menu mode.
8. Press the ▲ or ▼ button until the arrow in the display points to *REGISTRATION*.
9. Press PROGRAM/OK button and press ▲ or ▼ button to select *YES?*
10. Press the PROGRAM/OK button to confirm. The handset display shows:



TO REGISTER PUT  
HANDSET IN BASE

11. Place the handset in the base cradle to complete the registration. When registration is complete the display shows:



REGISTERED  
HANDSET #2

If the handset fails to register after 35 seconds, the display shows:



FAILED  
TRY AGAIN!

**IMPORTANT:** To successfully complete the registration, the base must be in REGISTRATION mode before the handset (ready for registration) is placed in the base cradle.

**NOTE:**

- The base remains in registration mode for 30 seconds. After the first handset is registered, you may continue registering additional handsets.
- A maximum of four handsets can be registered to the base.

## ADDING HANDSETS AND RE-INSTALLING THE SYSTEM

---

If you buy additional handsets to expand this system, you must register each new handset to the base. A maximum of four handsets can be registered to the base.

### ADDING ONE NEW HANDSET TO THE SYSTEM

Once your new handset is initialized, the display shows:



Follow instructions in the Handset Registration section to register your new handset.

**IMPORTANT: Your new cordless handset will not operate until it is registered to the base.**

### RE-INSTALLING THE SYSTEM

If you are not satisfied with the system, re-install it to improve performance.

1. De-register handset (refer to De-registration for instructions).
2. Follow instructions in the Handset Registration section to register the handset.
3. Repeat steps 1 and 2 for each handset.

## BASIC OPERATION

---

### INITIALIZATION AND STANDBY MODE

#### INITIALIZATION MODE

When the power is connected to the handset and base, the unit initializes all the hardware components, and the handset tries to synchronize with the base.

The display shows the following message for 5 to 10 seconds:

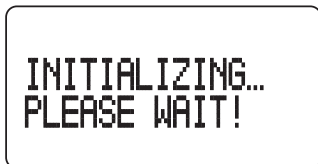

## BASE DISPLAY

When the phone is OFF, the base display shows the Current Time on the upper row of the screen, and Line Status/Prompt Message/Number of new CID or total Caller ID records received on the next line. It is not necessary for you to set up the clock time. The clock time is automatically updated when the unit receives Caller ID information. For example; when there are 12 new Caller ID in the database, the display shows:



OR

When there are 36 Caller ID records in the Caller ID database, and no new records have been received in the database, the display shows:



**NOTE: The handset uses the same display format for the Caller ID information.**

## LINKING THE HANDSET TO THE BASE

When the handset is OFF (not in TALK mode), it automatically changes to the battery saver mode. If the handset receives new information from the base, the handset display is updated.

If the handset and base are out of range, or the base power is turned OFF, the handset cannot link to the base. If you try to use the system resource, you will hear a warning beep, and the display shows:

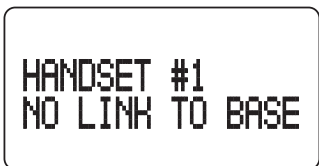

## MAKING EXTERNAL CALLS

### Manual Dialing:

1. Pick up the handset and press the TALK button on the handset. Wait for the dial tone.
2. Dial the number you want to call.
3. When finished, press the TALK button again to hang up. The call duration shows on the display.

**NOTE: If you dial more than 14 digits, the display only shows the last 14 digits.**

Follow the procedure above to make external calls with the base unit's speakerphone by pressing the SPEAKER button located on the base. When finished, press the SPEAKER button on the base to hang up.

#### **Pre-dialing:**

1. Make sure the phone is OFF (not in TALK mode).
2. Dial the number you want to call. The telephone number shows in the display.

**NOTE: If you make a mistake with the pre-dial number, you may use the ▲ or ▼ buttons to move the cursor forward or backward in the display, use the DELETE button to remove the wrong digit, and enter the correct digit.**

3. Press the TALK button on the handset. The number automatically dials.
4. When finished, press the TALK button again, to hang up. The call duration shows in the display.

**NOTE: You may enter up to 30 pre-dial digits but only the last 14 digits show in the display.**

Follow the procedure above to make external calls with the base unit's speakerphone by pressing the SPEAKER button located on the base. When finished, press the SPEAKER button on the base to hang up.

## **ANSWERING CALLS**

1. When the phone rings pick up the handset, and press the TALK button.
2. When finished, press the TALK button again to hang up.

**NOTE: When any handset is using the line, LINE IN USE shows in the display of all registered handsets.**

You may also answer calls with the base by pressing the SPEAKER button on the base.

## **CALL TIMER**

After you press the TALK button to make or answer a call, the built-in call timer shows on the display and counts the duration of the call in minutes and seconds.

## **VOLUME**

The handset, headset and speakerphone loudness can be adjusted independent of each other.

### **HANDSET RECEIVER VOLUME**

When in handset mode, adjust the cordless handset receiver volume by pressing Volume ▲/▼ keys on the handset. There are five volume levels. You will hear a warning tone when the volume reaches the maximum or minimum level.

**NOTE: If you do not press the volume ▲ or ▼ button within 5 seconds, the display returns to the previous menu.**

## HEADSET VOLUME

When in headset mode, adjust the headset volume with the ▲/▼ buttons on the handset. There are five volume levels. You will hear a warning tone when the volume reaches the maximum or minimum level.

## HANDSET SPEAKERPHONE VOLUME

In handset speakerphone mode, you may also adjust the handset speakerphone volume with the ▲/▼ keys. There are eight volume levels for the speakerphone.

## BASE SPEAKERPHONE VOLUME

When using the base speakerphone, you may also adjust the base speakerphone volume with the VOLUME ▲/▼ keys. There are eight volume levels for the speakerphone.

## SPEAKERPHONE OPERATION

The handset and base are equipped with speakerphone. When using the handset speakerphone you may switch to normal handset mode by pressing the TALK button. You may switch from handset mode to speakerphone mode with a press of the SPEAKER button. Toggling between speakerphone and normal operation does not disconnect the call.

## MAKING CALLS WITH THE SPEAKERPHONE

1. Press and release the SPEAKER button on the side of the handset and wait for a dial tone, or press and release the SPEAKER button on the base.
2. Dial the number (using a memory dial number, if desired) you want to call. The number shows on the display.
3. When the party answers, adjust speakerphone volume by pressing the volume ▲ or ▼ buttons on the opposite side of the handset. Or press the VOLUME button on the base.
4. When finished, press the SPEAKER button on the handset again or the SPEAKER button on the base.

**NOTE: You may also pre-dial a number or use a memory dial number, or review CID records you want to call, then press the SPEAKER button on the handset. Or press the SPEAKER button on the base.**

## ANSWERING CALLS WITH THE SPEAKERPHONE

1. When the phone rings, press and release the SPEAKER button on the side of the handset or press and release the SPEAKER button on the base.
2. Adjust speakerphone volume by pressing the volume up or down arrow buttons on the opposite side of the handset. Or press the VOLUME button on the base.
3. When finished, press the SPEAKER button on the handset again or SPEAKER button on the base.



## HEADSET

1. Plug the headset into the headset jack on the handset. When you are using the headset in TALK mode, the display shows:

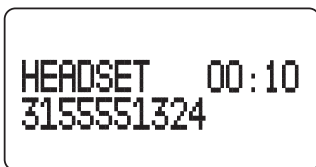

HEADSET 00:10  
3155551324

OR



INTERCOM TO #2  
HEADSET MODE

2. Unplug the headset when you want to use the handset or speakerphone.

**NOTE: The speakerphone and speakerphone button is disabled when the headset is plugged in. If the headset is unplugged, the system returns to normal operation in handset speakerphone mode. The base speakerphone operates normally when the headset is plugged into the handset.**

## REDIAL

1. Make sure the phone is OFF (not in TALK mode).

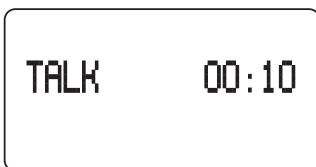

TALK 00:10

2. Press the TALK or SPEAKER button. The display shows:
3. Press the REDIAL button to redial the last number you dialed. The display shows:



TALK 00:12  
3155551324

## REDIAL PREVIEW DIALING

1. Make sure the phone is OFF (not in TALK mode).
2. Press the REDIAL button. The display shows:

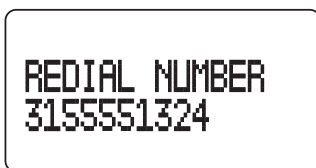

3. Press the TALK or SPEAKER button to pick up the line and automatically dial the number:

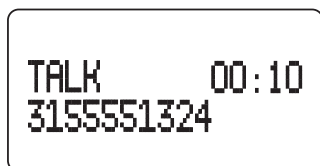

OR

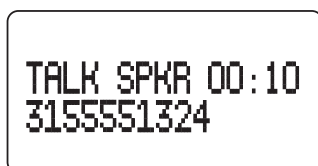

## HOLD

Press the HOLD button to place the call on hold and *LINE ON HOLD* shows in the display. The call remains on hold until you press the TALK or SPEAKER button if in speakerphone mode or the HOLD button on any registered handset.

While you are on the line, if you press the INT (intercom) button, the call is automatically placed on hold so you can use the intercom.

If a call is on hold for more than five minutes, the system automatically disconnects the call.

## HOLD REMINDER

When an outside line is on hold, Hold Reminder makes the system wait for a predetermined period of time before it generates a triple-beep reminder. The display shows *LINE ON HOLD* to remind you that a call is holding.

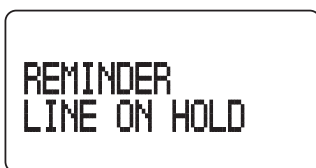

## HOLD RECALL RINGER

If the outside call is on hold for more than three minutes, all cordless handsets ring to remind you a call is still on hold. The display shows:



## INTERCOM

A 2-way call (intercom) is possible between two cordless handsets or between a registered handset and the base. And since the telephone line is not used, you may still receive incoming calls.

### MAKING INTERCOM CALLS

#### HANDSET

1. Press the INT/TRANSFER button on the handset when the phone is OFF (not in TALK mode). The display shows:

A rectangular display box with a black border containing the text "INTERCOM TO #".

2. Enter the handset number you want to call. For example, if your handset is #1 and you want to make an intercom call to Handset #2, enter a 2 at the prompt in the display. Or, if you want to make a call to the base, enter 0 at the prompt.

A rectangular display box with a black border containing the text "INTERCOM TO #2".

OR  
Handset

A rectangular display box with a black border containing the text "INTERCOM BASE".

#1's display shows:

A rectangular display box with a black border containing the text "INTERCOM TO #2 RINGING".

OR  
Handset

A rectangular display box with a black border containing the text "INTERCOM BASE RINGING".

#2's display shows:

A rectangular display box with a black border containing the text "INTERCOM FROM #1 RINGING".

**NOTE: If an intercom call is not answered within 60 seconds, the intercom call is automatically cancelled.**

If the system is busy (the intercom path is in use by another intercom caller or the Caller ID Database is busy), you will hear a warning tone when you press the INT button. The display shows:

INTERCOM BUSY

SYSTEM BUSY

OR

If Handset #2 is busy, Handset #1's display shows the following (Handset #2 will not hear an intercom tone):

INTERCOM TO #2  
BUSY

**NOTE: The called party remains undisturbed, and will not hear a call waiting triple beep for intercom call.**

If Handset #2's ringer is turned off, your display shows:

INTERCOM TO #2  
RING OFF

Handset #2's display shows:

INTERCOM FROM #1  
RING OFF

**NOTE: The called party can pick up the intercom call, even when the ringer is off.**

If you hear a warning tone and your display shows:

INTERCOM TO #2  
NOT FOUND

It means the handset you are calling either does not exist, is out of the range of the system, or is out of battery power.

**NOTE: To terminate the intercom call, the intercom caller may press the INT or EXIT button during intercom ringing.**

**NOTE: If the intercom is not answered within 60 seconds, the call is automatically cancelled.**

## BASE

1. When the phone is OFF (not in TALK mode), press the INTERCOM/PAGE/TRANSFER button on the base unit. The display shows:



>PAGE ALL?  
INTERCOM?

2. Using ▲ or ▼ button to select INTERCOM mode.



PAGE ALL?  
>INTERCOM?

3. Press the OK button to confirm. The display shows:



INTERCOM TO #

**NOTE: If you initiate an intercom call intercom and don't input a number (0-4), the intercom call is automatically cancelled after 10 seconds.**

## ANSWERING INTERCOM CALLS

When you receive an intercom call, your handset or base rings and the display shows:



INTERCOM FROM #3  
RINGING

OR



INTERCOM BASE  
RINGING

1. Press the INT/TRANSFER or TALK button to answer the intercom call. Your display shows:



INTERCOM FROM #3  
TALKING

OR



INTERCOM BASE  
TALKING

Or, press the SPEAKER button to answer the call in speakerphone mode. Your display shows:



INTERCOM FROM #3  
SPEAKERPHONE

2. Either party may press the INT/TRANSFER or EXIT button or TALK or SPEAKER button if in speakerphone mode to end the intercom call.

## USING INTERCOM WITH EXTERNAL CALLS

You may also make an intercom call when you are on the line with an external call.

1. If you press the INT/TRANSFER button when you're on the line, or when a call is on hold, your display shows:



>INTERCOM?  
TRANSFER?

2. With the arrow in the display pointing to INTERCOM, press the PROGRAM/OK button to choose intercom. The line is placed on hold.



INTERCOM TO #  
LINE ON HOLD

3. Enter the handset number you want to call. The handset you are calling rings.
4. To end the intercom call, either party may press the INT/TRANSFER, EXIT, TALK or SPEAKER button if in speakerphone mode. The call on the line remains on hold until you release it.

## RECEIVING AN INCOMING TELEPHONE CALL DURING AN INTERCOM CALL

If you receive a telephone call during an intercom call, both users are alerted with a ringing tone. Before you answer the telephone call, press the INT/TRANSFER, EXIT, TALK or SPEAKER button if in speakerphone mode to end the intercom call. Then press the TALK or SPEAKER button to take the telephone call.

## TRANSFERRING A CALL

You may transfer an external telephone call between two cordless handsets or between a registered handset and the base.

1. During a call, press the INT/TRANSFER button. The external call is put on hold, and the display shows:



>INTERCOM?  
TRANSFER?

2. Press the ▲ or ▼ button to move the arrow in the display to TRANSFER, and then press the PROGRAM/OK button.



TRANSFER TO #  
LINE ON HOLD

3. To page another cordless handset, or to transfer a call to the base enter the handset number or #0 for the base. For example, to transfer a call to Handset #2, press the 2 button and the display shows:



TRANSFER TO #2  
LINE ON HOLD

OR



TRANSFER BASE  
LINE ON HOLD

To answer a transferred call with the cordless handset, press the TALK or SPEAKER button when the handset rings.

### NOTE:

1. If the line has already been transferred, it cannot be transferred again until the transferred call is answered first.
2. If you don't press the number for the unit you want to transfer the call to within 10 seconds, transfer mode is automatically cancelled.

## TRANSFERRING AN OUTSIDE CALL THROUGH INTERCOM

1. If you want to make intercom call while talking on the line, press the INT/TRANSFER button. The line is put on hold automatically, and your display shows:



>INTERCOM?  
TRANSFER

2. Press the PROGRAM/OK button, followed by the number of the handset you want to intercom with. For example, if you want to intercom with handset #2, press the 2 button.



INTERCOM TO #2  
LINE ON HOLD

When the called party answers the intercom call, your display shows:



>TRANSFER?  
CONFERENCE?

3. To complete the transfer, press the PROGRAM/OK button when the arrow in the display points to TRANSFER. Your handset returns to the standby mode.

## CONFERENCE CALLS

This feature allows you to join two other calls to make a conference call. When you're on line, another handset user can join the call by pressing TALK or SPEAKER directly to make a conference.

## CONFERRING WITH AN EXTERNAL CALL AND INTERCOM

You can also make a conference call through an intercom call.

1. During an external call, press the INT/TRANSFER button to make an intercom call. The external call is automatically placed on hold. The display shows:



>INTERCOM?  
TRANSFER?



2. Press the PROGRAM/OK button to confirm the intercom followed by the handset number you want to intercom with. For example, if you want to intercom with Handset #2, press the 2 button.

When the called party answers the intercom call, your display shows:

>TRANSFER?  
CONFERENCE?

3. Use the ▲ or ▼ button move the arrow in the display to CONFERENCE?
4. Press the PROGRAM/OK button to set up the conference call. Your display shows:

CONF            03:20

**NOTE: Only the user who initiates the intercom may make a conference call.**

**NOTE: When a line is on hold but the call is not transferred, any handset may initiate the intercom call to participate in a conference call.**

## DIRECTORY MEMORY

You can store up to 10 names and numbers in your handset and 20 names and numbers in your base unit (15-character names and 24-digit telephone numbers may be stored in memory). The first record is stored as #01 and the last record in handset is #10 and #20 in the base.

### STORING NAMES AND NUMBERS IN MEMORY

1. Make sure the phone is OFF (not in TALK mode).
2. Press the DIRECTORY button. The display shows:

MEMO # 01  
EMPTY

3. Press the ▲ or ▼ button to select a different index or press the index number (01, 02.....10) directly to access the record.

4. Press the PROGRAM/OK button. The display shows:



5. Use the touch tone pad on your handset or base to enter a name (up to 15 characters). More than one letter is stored in each of the number keys. For example, to enter BILL SMITH, press the 2 number key twice to enter the letter B. Press the 4 number key 3 times to enter the letter I. Press the 5 number key 3 times to enter the letter L. Wait for a second for the cursor to move to the next location on the display, press the 5 number key 3 times to enter the letter L, and press the 1 number key twice to insert a space between the first and last name. Press the 7 number key 4 times to enter the letter S; press the 6 number key once to enter the letter M; press the 4 number key 3 times to enter the letter I; press the 8 number key once to enter the letter T; press the 4 number key twice to enter the letter H.

**NOTE: Use the ▲ or ▼ button to move the cursor around in the display. If you want to delete an incorrect character, press the DELETE button for each incorrect character.**

6. Press the PROGRAM/OK button to save. The display shows:

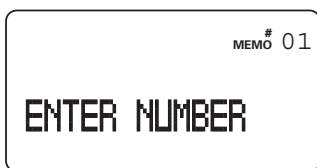

7. Enter the number, and the display shows:

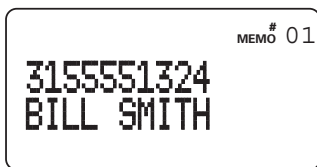

**NOTE: Use the # PAUSE button to insert a delay in the dialing sequence of a stored telephone number when a pause is needed (for example, when you must dial a 9 to get an outside line or when you must enter codes to access your bank's information line). Press #PAUSE button twice to insert a pause. Pause is displayed as "P."**

**NOTE: If a telephone number is more than 15 characters long, press the FORMAT button to view the remaining numbers.**

8. Press the OK button to store the name and number in memory. You will hear a confirmation tone, and the display shows:

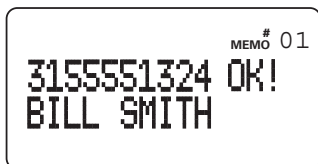

**NOTE: If you press the OK button on the base, you will not hear a confirmation tone, but RECORD NAME ANNOUNCEMENT? shows in the display. If you do not want to record the message on the base, press the OK button again to store the information.**

## RECORDING VOICE ANNOUNCEMENT ON THE BASE

For every number stored in the base directory, you may record a voice message (for example, a name) with it. This phone system checks the base directory database when it receives CID information. If the incoming CID number matches a number stored in the directory, the base announces the corresponding recorded voice message. If there is no match, the base announces the CID number information. If the telephone number is "Blocked" or a "Private number," it announces "Block Call." If the telephone number is not provided with the CID information, the system announces, "Unknown Call."

1. To store or edit a number and name, refer to Storing Names And Numbers Memory or Editing Names And Numbers From Memory section. After the final step, when you press the OK button on the base, the display shows the following message (for 30 seconds).



2. If you want to record the message, press VA RECORD on the base and wait for the beep tone. The display will show the following message for 2 seconds.



3. After hearing the beep tone, you can begin recording the message. Each record has 2-second message only. The display will show as follows and start to count the timer from 00 to 02.



4. When time is up (Time: 02), it will automatically stop recording. The display shows:

```
VOICE RECORD  
TIME:02
```

5. Then, it will play the voice message automatically for your reference. The display will show the following message.

```
RECORD  
AGAIN?
```

If you want to record it again, press the VA RECORD button to repeat steps 3 - 5.

6. If you are satisfied with the voice message, press OK button to store the name, number and the voice message. Then, it will generate a confirmation tone and show the following message for 3 seconds.

```
MEMO # 01  
3155551324 OK!  
BILL SMITH
```

## EDITING NAMES AND NUMBERS FROM MEMORY

1. Make sure the phone is OFF (not in TALK mode).
2. Press the DIRECTORY button into the directory mode.
3. Press  $\blacktriangle$  or  $\blacktriangledown$  button or enter the index number to select the index:

```
MEMO # 01  
3155551324  
BILL SMITH
```

4. Press PROGRAM/OK button to enter the editing mode. The display shows:

```
MEMO # 01  
BILL SMITH
```

**NOTE: Press the  $\blacktriangle$  or  $\blacktriangledown$  button to move the cursor.**

5. Change the name (for example: John Smith).

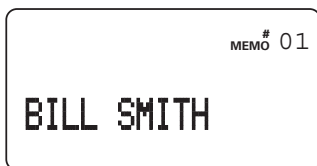

6. Press PROGRAM/OK button to store the name. The display shows:

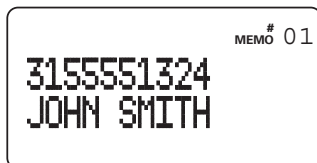

7. Change the number (for example: 3171234567). After editing the number, the LCD display:

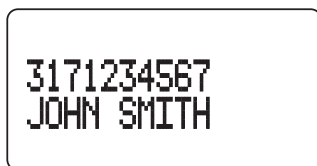

8. Press OK to store the name and number into the memory. It will generate a confirmation tone and show the following message for 3 seconds.

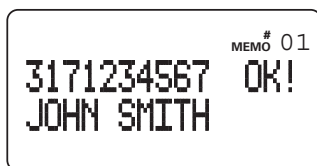

**NOTE: If you press the OK button on the base, you will not hear a confirmation tone, but RECORD NAME ANNOUNCEMENT? shows in the display. If you do not want to record the message on the base, press the OK button again to store information.**

**NOTE: If you edit the record with the base and don't re-record the voice announcement, the system retains the original voice message.**

## REVIEWING AND DELETING NAMES AND NUMBERS FROM DIRECTORY

1. Make sure the phone is OFF (not in TALK mode).

2. Press the DIRECTORY button into the directory mode. The display shows the memory #01.

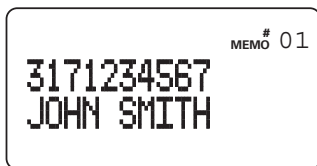

3. Press ▲ or ▼ button or enter the index number to select the directory index:

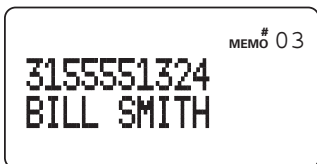

4. Press DELETE button to delete the record. The display shows:



5. Press DELETE button again to confirm. You will hear a confirmation tone and the display shows:

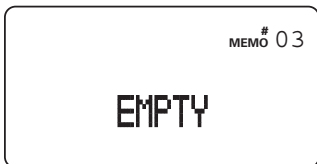

## **DIALING A NUMBER FROM DIRECTORY**

1. Make sure the phone is OFF (not in TALK mode).
2. Press the DIRECTORY button into the directory mode.
3. Press ▲ or ▼ button or enter the index number to select the index:

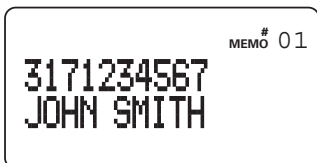

4. Press TALK or SPEAKER button to take the line and dial out the number. The display shows:

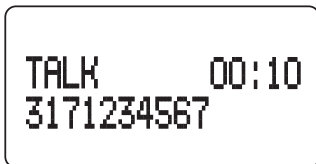

**NOTE: If the content is "EMPTY," and you press the TALK or SPEAKER button, the phone takes the line but will not dial a number.**

## DIALING AFTER PICKING UP THE LINE

1. Make sure the phone is ON by pressing TALK button. The display shows:

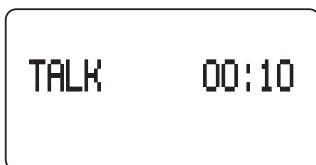

2. Press the DIRECTORY button, the display shows:

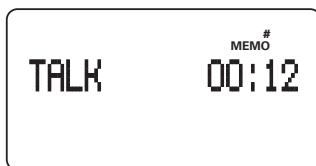

3. Enter the index number (for example: "01"). The phone will dial out the #01 record number automatically.

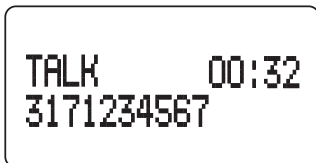
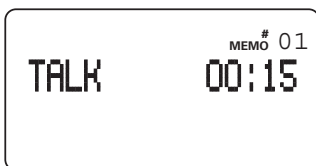

## CHAIN DIALING FROM DIRECTORY MEMORY

Use this feature to make calls that require a sequence of numbers, such as a calling card number used for a frequently called long distance number. The following example shows how you can store each part of the long dialing sequence and use chain dialing to make a call through a long distance service.

<i>The Number For</i>	<i>Memory Location</i>
Long Distance Access Number	07
Authorization Code	08
Frequently called long distance number	09

1. Make sure the phone is ON (in TALK mode) by pressing the TALK or SPEAKER button.
2. Press the DIR button, and then press 07.
3. When you hear the access tone, press the DIR button, and then press 08.
4. At the next access tone, press the DIR button and then 09.

**NOTE:**

**1.) Chain-Dialing combinations may include:**

**Manual Dialing + Directory**  
**Directory + Manual Dialing**  
**Directory + Directory**

**2.) If you use Caller ID with Chain-Dialing, you must dial the Caller ID number first. Otherwise, it will not work.**

**Caller ID Number + Manual Dialing**  
**Caller ID Number + Directory**

## **CALL WAITING CALLER ID (CID)**

Caller ID (CID) is a call identification service available from your local telephone company. To receive CID information on this system, you must subscribe to CID service through your local telephone company.

When your telephone rings, and you are subscribed to Caller ID service, your cordless telephone receives CID information (if available) transmitted from your local telephone company.

Call Waiting Caller ID service lets you see who is calling while you are on the phone. When you are on the phone and you receive a Call Waiting Caller ID call, you hear a tone in the receiver signifying there is a call waiting on the line, and CID information shows in the display. If desired, you may press the FLASH button to put the first call on hold and answer the call waiting call.

## **CALLER ID (CID) DATABASE**

If you are not at home or cannot answer a call, your multi-handset system stores CID up to 50 (each CID record includes the first 15 characters for a name and the last 15 digits for a number). records in the CID database on the base. When the 51<sup>st</sup> call is received, the oldest CID record (1<sup>st</sup> call) is automatically deleted.

Any cordless handset on the system may access the CID database, but only one cordless handset at a time may retrieve and view CID memory. You may review the stored information for the most recent 50 at any time. Calls received since your last review show as # in the display.

**NOTE: The system uses the intercom radio path to access and retrieve information from the CID database. When the CID database is in use, the intercom cannot be used. Conversely, when the intercom is in use, CID memory cannot be accessed.**



## CALLER ID DISPLAY SCREEN

You will see this display screen when you receive a new call.

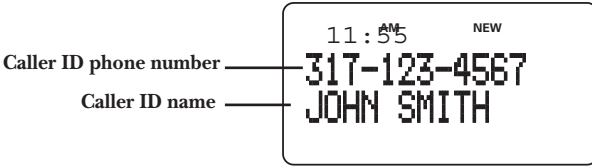

## CALLER ID INFORMATION VOICE ANNOUNCEMENT (FOR CALLER ID TYPE 1 ONLY)

Press the VA ON/OFF button to turn on the feature. The VA ON/OFF indicator turns on. This phone system checks the base directory database when it receives CID information. If the incoming CID number matches a number stored in the directory, the base announces the corresponding recorded voice message. If there is no match, the base announces the CID number information. If the telephone number is "Blocked" or a "Private number," it announces "Block Call." If the telephone number is not provided with the CID information, the system announces, "Unknown Call." To record a voice message, refer to the Directory Memory - Recording Voice Announcement on the Base section.

**NOTE: The VA function must be turned on. When it's ON, the VA ON/OFF indicator turns on.**

## REVIEWING CID RECORDS

As calls are received and stored, you may access the CID Database to review the records.

1. Make sure your phone is OFF (not in TALK mode).
2. Press the CID button to enter Caller ID retrieve mode. The display shows the number of new CID records and the total number of CID records. For example, the database may have 12 new caller ID records and 36 total caller ID records.

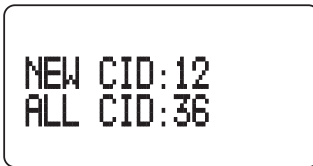

If the database is empty, the display shows:

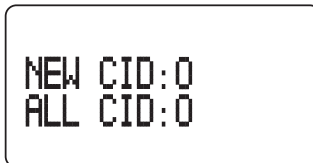

3. Press the ▲ or ▼ button to scroll through the CID database. The display shows new and repeated call information and the index number.

**NOTE: A call may be new and repeated if two calls from the same caller are received on the same date.**

For example, the display shows:

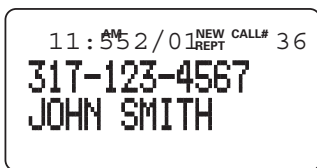

**NOTE: If you try to access the CID database while another user is accessing the CID Database, the display shows SYSTEM BUSY.**

**NOTE: If the link between the handset and the base is interrupted while you access the CID Database, the display shows NO LINK TO BASE TRY AGAIN! You should press the CID or ^ or v button to access the CID Database again.**

## DELETING A CID RECORD

You may delete a CID record from the caller database when the CID record shows in the display.

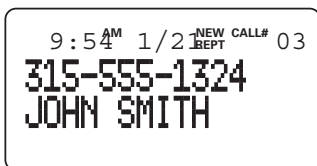

1. Press the DELETE button. The display shows:

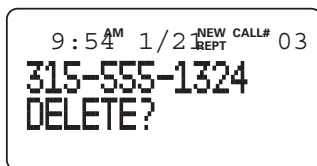

2. Press the DELETE button again to confirm. You will hear a confirmation beep. *DELETED* shows in the display, and the next CID record appears.

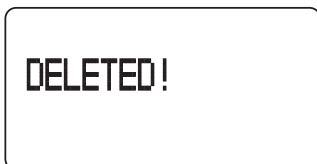

## DELETING ALL CID RECORDS FROM THE CID DATABASE

You may delete all CID records from the Caller ID database after you return the call or you have reviewed the caller list.

1. Make sure the phone is OFF (not in TALK mode).
2. Press the CID button to enter the CID retrieve mode. The display shows:

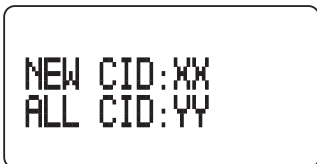

NEW CID:XX  
ALL CID:YY

3. Press the DELETE button to delete all Caller ID records. The display shows:



NEW CID:XX  
DELETE ALL?

4. Press the DELETE button again to confirm. The display shows:

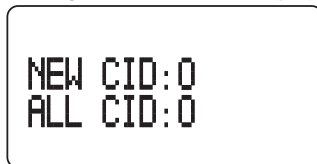

NEW CID:0  
ALL CID:0

## DIALING A CID RECORD

While reviewing the Caller ID records, you may dial the phone number showing in the display. For example: The display shows the caller information, and you want to return the call.

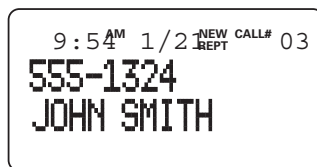

9:54<sup>AM</sup> 1/2<sup>NEW CALL#</sup>  
555-1324  
JOHN SMITH  
REPT 03

There are three ways to dial a Caller ID record. Always press the FORMAT button to select the method in which you want to dial the number. The format changes in sequence with 7-8-10-11 formatting.

1. Add the leading digit (1). The display shows:

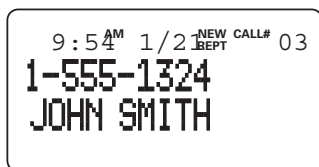

2. Add the original area code. The display shows:

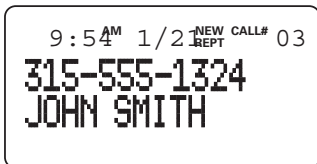

3. Add the leading digit (1) and original area code:

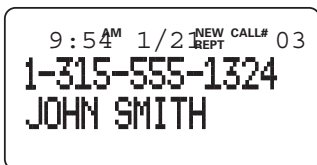

After you select the dialing format, press the TALK or SPEAKER button the number is dialed automatically.

**NOTE: If you do not press the FORMAT button, the system checks all local area and all regional area codes. If the caller's area code is the same as your local area code, it automatically dials the original 7 digits. If the area code is not matched, the system automatically adds the leading (1).**

## TRANSFERRING A CID RECORD TO DIRECTORY MEMORY

You may store CID records in Directory. While reviewing CID records:

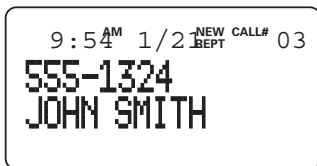

1. Press the FORMAT button. The display shows:

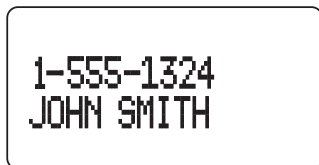

2. After you select the dialing format, press and hold the DIRECTORY button to enter the directory. The display shows:

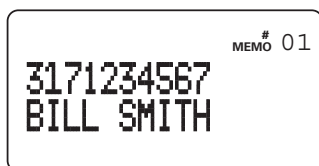

3. Press the ▲ or ▼ button to select the memory location (Memo #).



4. Press the OK button to confirm the selection. The display shows:



5. Press the ▲ or ▼ to select YES.



6. For handsets, press the OK button to confirm. You will hear a confirmation tone and the display returns to the Caller ID retrieve mode.

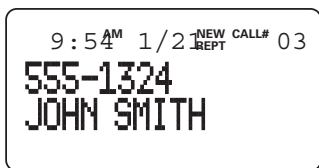

For the base, press the OK button. You will not hear a confirmation tone. The display shows:



If you don't want to record the voice message on the base, press the OK button again to store the record in the directory instead. You will hear a confirmation tone and automatically return to the Caller ID retrieve mode.

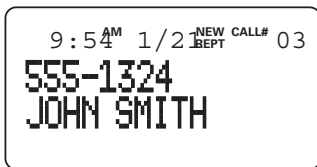

**NOTE: If you don't press the OK button, record is not stored in the directory.**

To record the voice message, refer to "Recording Voice Announcement On the Base."

**NOTE:**

- 1. If you press the DIRECTORY button for less than one second, you will scroll the directory contents.**
- 2. If you don't press the FORMAT button to store the record, the system checks all regional area codes. If the caller's area code is NOT the same as one of the six regional area codes, the system adds the leading (1) when you press the DIRECTORY button.**

## **CALL WAITING CALLER ID DELUXE**

This phone system is Call Waiting Caller ID Deluxe compatible so you may receive Call Waiting Caller ID information from your local telephone company's central office. There is a Call Waiting Type (2.0/2.5) selection switch on the back of the unit. When the telephone company provides Call Waiting Type 2.5 service (not available in all areas), you may set the switch to Type 2.5 position to activate the 2.5 function buttons.

1. When you are on the line, the display shows:

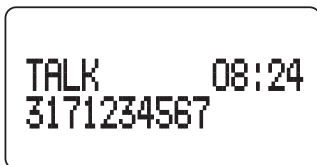

2. After you hear a short alert signal, the display automatically shows the incoming Caller ID information.

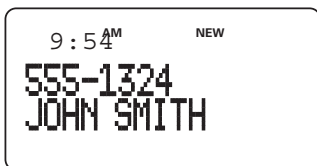

3. If the Caller ID Type 2.5 functions are turned on, the display shows:



**NOTE:**

1. If you don't press any buttons for 15 seconds, the icons on the bottom row of the display show for 15 seconds. When icons disappear, the functions are disabled.
2. When the Type 2.5 function is ON, only TALK, FLASH, and the corresponding button are functional. The other buttons are disabled and will generate a warning beep if you press them.
3. Caller ID Type 2.5 works on both handsets and the base unit.

## CALLER ID TYPE 2.5 FUNCTIONS

### BUSY

1. Make sure Caller ID Type 2.5 is ON.

If you receive CID information while you are on the line, the display shows:



2. Press the INFO/BUSY button to send a busy signal to the central office. The display shows the following messages for 3 seconds.



The unit does not display any dial out information. Instead, it shows:

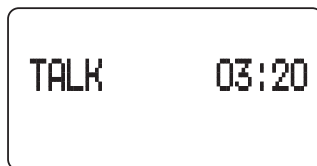

## CONFERENCE

1. Make sure Caller ID Type 2.5 is ON.

If you receive CID information while you are on the line, the display shows:



2. Press the CONF/REPEAT DIAL button to send the conference signal to the central office. The display shows:

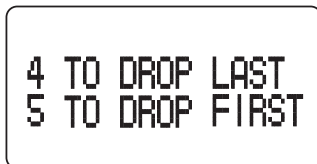

3. Press the TALK or SPEAKER button if in speakerphone mode to release the conference call, press 4 to drop the last call, or press 5 to drop the first call.

**NOTE: If you press 4 to drop the last call, the central office drops the last call and keeps the first call. If you press 5 to drop the first call, the central office drops the first call and keeps the last call. In both cases, the display shows:**

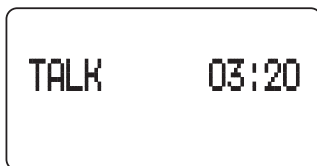

## VOICE MAIL

1. Make sure Caller ID Type 2.5 is ON.

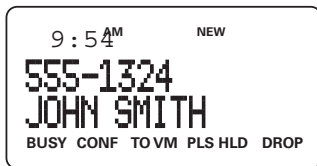

If you receive CID information while you are on the line, the display shows:

2. Press the VOICE MAIL/TO VM button to send the "Switch to Voice Mail" command to the central office. The central office automatically switches the caller to voice mail. The display shows:





TO VOICE MAIL

The unit does not display any dial out information. Instead, it shows:



TALK 03:20

## PLEASE HOLD

1. Make sure Caller IDType 2.5 is ON.

If you receive CID information while you are on the line, the display shows:



9:54<sup>M</sup> NEW  
555-1324  
JOHN SMITH  
BUSY CONF TOVM PLS HLD DROP

2. Press the REDIAL/PLS HOLD button to send the "Hold the First Call and Connect the Last Call" command to the central office. The central office automatically holds the first call and connects the last call. The display shows:



9:54<sup>M</sup> NEW  
1RETURN 1DROP  
3 COFERENCE

3. Press the TALK or SPEAKER button if in speakerphone mode to release the call, press 1 to pick up the original call, press 3 to build the conference call, or press 7 to drop the last call.

## RETURN THE OTHER CALL

- When you press 1 to pick up the first call, the central office automatically holds the last call and picks up the first call. The unit still displays:



9:54<sup>M</sup> NEW  
1RETURN 1DROP  
3 COFERENCE

- If you press 1 again, the central office automatically holds the current line and picks up the line on hold.

## BUILD THE CONFERENCE CALL

- When you press 3 to build the conference call, the central office automatically builds the conference call. The display shows:

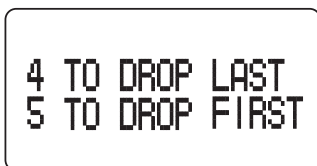

- You may press the TALK or SPEAKER button if in speakerphone mode to release the conference call, press 4 to drop the last call, or press 5 to drop the first call.
- If you press 4 to drop the last call, the central office automatically drops the last call and keeps the first call. If you press 5 to drop the first call, the automatically drops the first call and keeps the last call.

In both cases, the display shows:

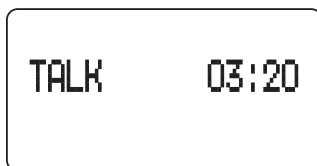

## DROP THE LAST CALL

- When you press 7, the central office automatically drops the last call and picks up the first call. The unit still displays:

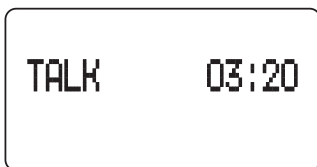

## DROP

1. Make sure Caller ID Type 2.5 is ON.

When you receive CID information while you are on the line, the display shows:



2. Press the AUTO REDIAL/DROP button. The display shows:



And then the display shows:

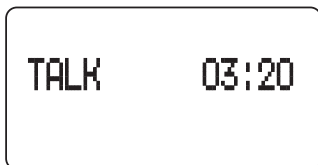

## **ANSWER**

1. Make sure Caller IDType 2.5 is ON.

When you receive CID information while you are on the line, the display shows:

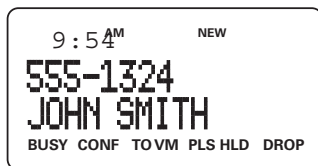

2. Press the FLASH button. The display shows:

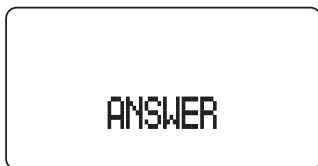

And then the display shows:

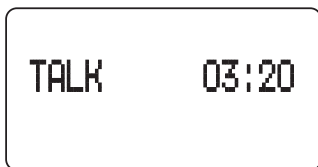

# DISPLAY MESSAGES

When the system is in standby mode, the following messages may show in the display according to the handset and line status:

<b>XX NEW CALLS</b>	XX represents the number of new Caller ID records not reviewed.
<b>XX CID RECORDS</b>	Caller ID memory received XX number of caller ID records.
<b>LINE IN USE</b>	The telephone line is in use.
<b>LINE ON HOLD</b>	The telephone line is holding.
<b>LOW BATTERY</b>	Battery power is low and needs to be charged.
<b>MESSAGE WAITING</b>	A message is waiting.
<b>NO LINK TO BASE</b>	The handset cannot be linked with the base.

When you receive a new phone call, the following messages may show in the display according to the status:

<b>NO NAME:</b>	The caller's name is not transmitted.
<b>NO NUMBER:</b>	The caller's telephone number is not transmitted.
<b>UNKNOWN NAME:</b>	The caller's name is unknown or out of area.
<b>UNKNOWN NUMBER:</b>	The caller's number is unknown or out of area.
<b>BLOCKED NAME:</b>	The caller's name is private and is blocked from transmission.
<b>BLOCKED NUMBER:</b>	The caller's number is private and is blocked from transmission.
<b>UNKNOWN CALL:</b>	Both the caller's name and number is unknown or out of area.
<b>BLOCKED CALL:</b>	Both the caller's name and number is private and is blocked from transmission.
<b>LONG DISTANCE:</b>	The number is a long Distance number.
<b>INCOMPLETE DATA:</b>	The Caller ID information is incomplete.

**NOTE: The INCOMPLETE DATA messages are not stored in the database.**

## NOTE:

- 1. CALL# 05 icon – This means the call data is stored in index #05 in the Caller ID database.**
- 2. REPT icon – This means the call is received at least twice on the same date. If the Caller ID record is not a new record, the REPT icon doesn't appear, but if the same user calls again on the same date, the REPT icon shows in the display.**
- 3. Month/Date icon - Month range is 1-12 and the date range is 01-31. If the month/date data is out of range, the display is blank for the month/date. If the date range is 01-09, the leading zero is displayed.**
- 4. Time icon: The display show the hour and minute a call is received  
Hour : Minute AM/PM.**
- 5. If the system receives the long distance information for a caller, LONG DISTANCE does not show in the display.**
- 6. REPT and CALL # counter icons won't display when you receive Caller ID type 1 and type 2 data. The icons show in the Caller ID database retrieving mode only.**

7. When CID number has between 5 and 11 digits, the number format is displayed as x-xxx-xxx-xxxx. If the CID number has less than 5-digits or more than 11-digits, the display does not show hyphens between the digits.
8. If a Caller ID number is more than 15 digits, the display only shows the last 15 digits.

## SPECIAL FEATURES

---

### CHARGE/PAGE INDICATOR

The CHARGE/PAGE indicator is ON when the handset is placed on the cradle and indicates the handset is charging. If you page the cordless handsets, the indicator flashes.

### IN USE/V-MAIL INDICATOR

When the telephone line is in use, the in use/V-Mail indicator turns ON. When the telephone line is on hold or a voice mail message is waiting, the indicator flashes.

### MESSAGE WAITING

Your telephone company may send you a "Message Waiting" signal when you receive voice mail messages. You may retrieve the messages from your telephone company with an access code. *MESSAGE WAITING* shows in the display, and the IN USE/V-MAIL indicator on the base and Voice Mail indicator on the handset flashes to let you know a message is waiting. To retrieve messages, refer to instructions in VOICE MAIL BUTTON section.

### PAGING ALL HANDSETS

The page feature helps you locate a misplaced handset. To send and receive pages, all cordless handsets must be registered. If a handset is not registered, refer to the Handset Registration of this manual for instructions.

1. Make sure the phone is OFF (not in TALK mode).
2. Press the INTERCOM/PAGE/TRANSFER button on the base. The display shows:



```
>PAGE ALL?  
INTERCOM?
```

3. Press the OK button to confirm. All handsets generate the paging tone for 60 seconds and display the following message:

PAGING  
FROM BASE

If the phone is in use and you press the INTERCOM button on the base unit, the display shows:

>INTERCOM?  
TRANSFER?

**NOTE:**

1. **The paging tone volume level is fixed to “High”. You may press the EXIT button or any digit on the handset’s touch-tone pad to immediately stop the paging tone.**
2. **Paging tone still sounds even if the Ringer is set to OFF on Handsets.**

4. Press the INTERCOM/PAGE/TRANSFER button on the base again to stop paging.

## FLASH

Use the FLASH button to activate custom calling services such as call waiting or call forwarding, which are available through your local phone company. If you subscribe to the combined Call Waiting Caller ID service from your local telephone company, you will receive Caller ID information (if available) on Call Waiting calls. During a phone call, you will hear a beep to indicate another call is waiting on the line and Caller ID information for the waiting call shows on the handset display. To connect to the waiting call.

1. Press the FLASH button when you hear the call-waiting tone. The first call is automatically placed on hold so you can answer the second call.
2. To return to the first caller, press the FLASH button again. You may switch back and forth between the two calls by pressing the flash button.

**NOTE: If this function does not operate properly, contact your local telephone company.**

**TIP: Don’t press the TALK button on the cordless handset to activate a custom calling service, such as call waiting, or you’ll hang up the phone.**

## PAUSE

Use the #PAUSE button to insert a delay in the dialing sequence of a stored telephone number when a pause is needed (for example, when you must dial a 9 to get an outside line or when you must enter codes to access your bank’s information line). You may insert a PAUSE when in the directory mode, pre-dialing mode or Voice Mail and Info Service number memory. Press #PAUSE button twice to insert a pause. Pause is displayed as “ P”

**NOTE: You may add more than one pause if a longer delay is needed in the dialing sequence.**

## MUTING YOUR CONVERSATION

Use mute to turn off the handset microphone so you can have a private, off-line conversation. The party on the other end of the line cannot hear you, but you can still hear them.

1. Press the MUTE button while talking. *MUTE* shows in the display.

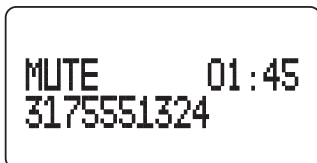

2. Press the MUTE button again to resume your phone conversation.

**NOTE: If you hang up the handset or press the FLASH button, MUTE is automatically cancelled.**

## OUT OF RANGE WARNING

While using your cordless handset, if you move too far away from the base, you will hear a five-second double warning tone and the display shows *OUT OF RANGE*. Move closer to the base and the warning tone stops. If you do not move back within range of the base within 30 seconds, the handset loses its link with the base and the base automatically puts your call on hold.

## BATTERY LOW WARNING

When the battery voltage level is low, a warning message appears and you will hear a warning beep. If you are on the line, you will hear the warning beep every 15 seconds. Finish your call as soon as possible, or after approximately 5 minutes your call is put on hold automatically. You will need to use another handset to retrieve the call within five minutes or the call is disconnected.

## 3-WAY CONFERENCE (FLASH 3-WAY EXIT)

1. Call the first party to setup the call.
2. Press FLASH/3 WAY/EXIT button to put the first party on hold.
3. Call the second party.
4. Press FLASH/3 WAY/EXIT button and 3-way conference is established.

## TELEPHONE COMPANY SERVICE BUTTONS

Your handset has four dedicated buttons for use with special telephone company services. They are:

### VOICE MAIL BUTTON

This button stores your voice mail access number (up to 20 digits). The factory default is *EMPTY*.

1. When the phone is on the line, press the VOICE MAIL button and the unit automatically dials your pre-programmed voice mail number.

OR

2. When the phone is idle, press the VOICE MAIL button and the system automatically takes the line and dials your pre-programmed voice mail number.

## INFO BUTTON

This button stores the telephone company's Information Services number (up to 11 digits). The factory default is 411. When the phone is active, press the INFO button and the system dials the pre-programmed Information Services number.

OR

When the phone is idle, press the INFO button, and the system automatically takes the line and dials your pre-programmed Information Services number.

## REPEAT DIAL BUTTON

This button allows you to continuously redial the last number you dialed. Your local telephone company sets the default, and you may not change it.

1. If the number you dial is busy, press the REPEAT DIAL button and the system automatically sends the command to your local telephone company where the number is repeatedly dialed on your behalf.

OR

2. When the system is idle, press the REPEAT DIAL button and the system automatically takes the line and sends your command to your local telephone company where the number is repeatedly dialed by the telephone company on your behalf.
3. If the number is busy and you don't want to stay on the line, press the TALK button to hang up the phone. Your local telephone company continues to redial the number for a specified amount of time. A special ringer tone is generated when the call connects. Pick up the handset and wait for the party to answer.

**NOTE: To cancel the repeat dial command, dial \*86.**

## AUTO REDIAL BUTTON

This button lets you to perform auto redial through your local telephone company. Your local telephone company sets the default, and you may not change it.

1. With the phone on line, press the AUTO REDIAL button. The system send your request to your local telephone company where the last call you received is automatically redialed on your behalf.

OR

2. When the system is idle, press the AUTO REDIAL button and the system automatically takes the line and sends your request to your local telephone company where the last call you received is automatically redialed on your behalf.
3. If the number is busy and you don't want to stay on the line, press the TALK button to hang up the phone. Your local telephone company continues to redial the number for a specified amount of time. A special ringer tone is generated when the call connects. Pick up the handset and wait for the party to answer.

**NOTE: To cancel the command, dial \*89.**



## TELEPHONE COMPANY SERVICES LIMITATIONS

The four telephone company buttons have the following limitations:

- If the line is in use by an extension telephone or other device, such as a computer modem or facsimile machine, you will not be able to use the line.
- If the content of a specific feature button is empty, your cordless phone cannot perform that function.
- If the line is in use by another handset, the system sends a FLASH signal to your local telephone company, then sends the digits to your telephone company to access your telephone company features.
- The telephone numbers you use with the telephone company features are not stored in the redial memory.

## REPLACING THE BATTERY



**CAUTION: To reduce the risk of fire or personal injury, use only the battery, part number 5-2569, which is compatible with this unit.**

1. Remove the battery compartment cover located on the back of the handset.
2. Disconnect the battery pack cord from the jack inside the battery compartment and remove the old battery.
3. Connect the new battery pack and place it in the compartment.
4. Put the battery compartment cover back on.
5. Place the handset in the charge cradle, and allow it to charge for 6 hours. If you don't properly charge the handset, battery performance is compromised.

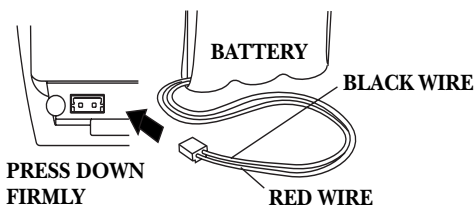
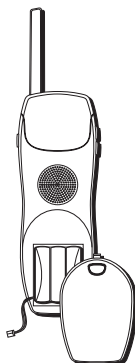

## BATTERY SAFETY INSTRUCTIONS

- Do not burn, disassemble, mutilate, or puncture. Like other batteries of this type, toxic materials could be released which can cause injury.
- Keep batteries out of the reach of children.
- Remove batteries if storing over 30 days.

# TROUBLESHOOTING TIPS

---

## TELEPHONE SOLUTIONS

---

No dial tone:

- Check or repeat installation steps:  
Ensure the base power supply cord is connected to a working electrical outlet.  
Ensure the telephone line cord is connected to the base and the modular telephone line jack.
  - Connect another phone to the same jack. If it doesn't work, the problem might be your wiring or local service.
  - The handset may be out of range of the base. Move closer to the base.
  - Ensure the battery is properly charged (for 6 hours).
  - Ensure the battery pack (in the handset) is properly installed.
  - Does the handset beep when you press the TALK button? Does the IN USE/V-MAIL indicator on the base turn on? The battery may need to be charged.
  - Place handset in charge cradle for at least 20 seconds to reset the unit.
- 

Handset does not ring:

- Make sure the handset ringer soft switch is set to on.
  - The handset may be out of range of the base. Move closer to the base.
  - You may have too many extension phones on your line. Try unplugging some extension phones.
  - Check for a dial tone.
- 

You experience static, noise, or fading in and out:

- The handset may be out of range of the base. Move closer to the base.
  - Make sure base is not plugged into an electrical outlet with another household appliance. If necessary, relocate the base.
  - Charge the battery (for 6 hours).
- 

Unit beeps:

- Clean the charging contacts on the cordless handset and charge cradle with a soft cloth or an eraser.
  - See solutions for "No dial tone."
  - Replace the battery.
- 

Memory Dialing doesn't work:

- Ensure the memory location keys are programmed correctly.
  - Ensure proper dialing sequence is followed.
- 

Unit locks up and no communication between the base and cordless handset:

- Unplug the AC power supply from the electrical outlet and the back of the base. Remove the handset battery. Wait for 30 seconds and plug the power supply back into the base and electrical outlet. Reconnect the battery and charge for 6 hours.
-

IN USE/V-MAIL Indicator on the base flashes:

- Provided your phone company offers voice messaging service and you subscribe to it, the IN USE/V-MAIL indicator on the base flashes when the phone is not in use to indicate there is a message waiting. It stops flashing after the message is reviewed.
- 

## CALLER ID SOLUTIONS

---

No display:

- Charge the battery (for 6 hours), or replace the battery.
  - Make sure the unit is connected to a non-switched electrical outlet.  
Disconnect the AC power supply from the base and reconnect it.
- 

Caller ID error message:

- The unit displays this message if it detects anything other than valid Caller ID information during the silent period after the first ring. This message indicates the presence of noise on the line.
- 

No Caller ID:

- You must be subscribed to Caller ID service from your local telephone company to receive Caller ID information.
- 

## BATTERY SOLUTIONS

If you experience any of the following problems, even after recharging the battery, you may need to replace the battery pack:

- Short talk time
- Poor sound quality
- Limited range
- Charge indicator fails to turn on

## GENERAL PRODUCT CARE

---

To keep your unit working and looking good, follow these guidelines:

- Avoid dropping the handset, as well as other rough treatment to the phone.
- Clean the phone with a soft cloth.
- Never use strong cleaning agents, paint thinner, abrasive powder, alcohol, or other chemical products to clean the unit. Doing so will damage the finish.
- Retain the original packaging in case you need to ship the phone at a later date.
- Periodically clean the charge contacts on the handset and base with a clean soft cloth.

## CAUSES OF POOR RECEPTION

---

- Aluminum siding.
- Foil backing on insulation.
- Heating ducts and other metal construction that can shield radio signals.
- You 're too close to appliances such as microwaves, stoves, computers, etc.
- Atmospheric conditions, such as strong storms.
- Base is installed in the basement or lower floor of the house.
- Base is plugged into AC outlet with other electronic devices.
- Baby monitor is using the same frequency.
- Handset battery is low.
- You 're out of range of the base.

## SERVICE

---

FCC requires this product be serviced only by the manufacturer or its authorized service agents. In accordance with FCC requirements, changes or modifications not expressly approved by ATLINKS USA, Inc. could void the user's authority to operate this product.

Attach your sales receipt to the booklet for future reference or jot down the date this product was purchased or received as a gift. This information will be valuable if service should be required during the warranty period.

Purchase date \_\_\_\_\_

Name of store \_\_\_\_\_

# INDEX

---

## Symbols

3-Way Conference (FLASH 3-WAY EXIT) 63

## A

Adding Handsets and Re-Installing the System 29

Adding One New Handset to the System 29

Answer 59

Answering Calls 31

Answering Calls with the Speakerphone 32

Answering Intercom Calls 37

Auto Redial Button 64

## B

Base 26, 37

Base Display 30

Base Layout 9

Base Speakerphone Volume 32

Basic Operation 29

Battery Low Warning 63

Battery Safety Instructions 65

Battery Solutions 67

Build the Conference Call 58

Busy 55

## C

CallTimer 31

Call Waiting Caller ID (CID) 48

Call Waiting Caller ID Deluxe 54

Caller ID (CID) Database 48

Caller ID Display Screen 49

Caller ID Information Voice Announcement (For Caller IDType 1 Only) 49

Caller ID Solutions 67

Caller IDType 2.5 Functions 55

Causes of Poor Reception 68

Chain Dialing from Directory Memory 47

Charge/Page Indicator 62

Conference 56

Conference Calls 40

Conferencing with an External Call and Intercom 40

## D

Data Port 14

Deleting a CID Record 50

Deleting All CID Records from the CID Database 51

Deregistration 24

Dialing A CID Record 51

Dialing a Number from Directory 46

Dialing after Picking Up the Line 47

Directory Memory 41

Display Messages 60

Drop 58

Drop the Last Call 58

## **E**

- Editing Names and Numbers from Memory 44
- Editing the Info Service Number 21
- Editing the Voice Mail Number 20
- Equipment Approval Information 2

## **F**

- FCC RF Radiation Exposure Statement 3
- Flash 62

## **G**

- General Product Care 67
- Getting to Know Your Multi-handset Cordless System 7

## **H**

- Handset 24, 35
- Handset and Base Buttons 11
- Handset Layout 9
- Handset Receiver Volume 31
- Handset Registration 27
- Handset Speakerphone Volume 32
- Headset 33
- Headset Volume 32
- Hearing Aid Compatibility (HAC) 3
- Hold 34
- Hold Recall Ringer 34
- Hold Reminder 34
- Hold Reminder/Ringer 22

## **I**

- Important Installation Guidelines 13
- In Use/V-Mail Indicator 61
- Info Button 64
- Initialization and Standby Mode 29
- Initialization Mode 29
- Installation 12
- Installing the Phone 13
- Intercom 35
- Intercom Ringer 16
- Interference Information 3
- Introduction 7

## **L**

- Language 15
- Limited Warranty 72
- Line Ringer 17
- Linking the Handset to the Base 30
- Local Area Code 19

## **M**

- Making Calls with the Speakerphone 32
- Making External Calls 30
- Making Intercom Calls 35
- Menu Mode 15
- Message Waiting 61
- Muting Your Conversation 63

## **O**

Out of Range Warning 63

## **P**

Paging All Handsets 61  
Parts Checklist 12  
Pause 62  
Please Hold 57  
Programmable Functions 14

## **R**

Re-Installing the System 29  
Receiving an Incoming Telephone Call During an Intercom Call 39  
Recording Voice Announcement on the Base 43  
Redial 33  
Redial Preview Dialing 34  
Regional Area Codes 20  
Repeat Dial Button 64  
Replacing the Battery 65  
Resetting the Handset and Base to the Factory Default 23  
Return the other Call 57  
Reviewing and Deleting Names and Numbers from Directory 45  
Reviewing CID Records 49  
Ringer Type 18  
Ringer Volume 17

## **S**

Service 68  
Speakerphone Operation 32  
Special Features 61  
Storing Names and Numbers in Memory 41

## **T**

Telephone Company Buttons 11  
Telephone Company Service Buttons 63  
Telephone Company Services Limitations 65  
Telephone Jack Requirements 12  
Telephone Solutions 66  
Transferring a Call 39  
Transferring A CID Record To Directory Memory 52  
Transferring an Outside Call Through Intercom 40  
Troubleshooting Tips 66

## **U**

Using Intercom with External Calls 38

## **V**

Voice Mail 56  
Voice Mail Button 63  
Volume 31

# LIMITED WARRANTY

---

## **What your warranty covers:**

- Defects in materials or workmanship.

## **For how long after your purchase:**

- One year.

(The warranty period for rental units begins with the first rental or 45 days from date of shipment to the rental firm, whichever comes first.)

## **What we will do:**

- Provide you with a new or, at our option, a refurbished unit.
- The exchange unit is under warranty for the remainder of the original product's warranty period.

## **How to make a warranty claim:**

- For information regarding a warranty claim, call the toll free number located on the bottom of your unit.

## **What your warranty does not cover:**

- Customer instruction. (Your Owner's Manual provides information regarding operating instructions and user controls. For additional information, ask your dealer.)
- Installation and setup service adjustments.
- Batteries.
- Damage from misuse or neglect.
- Products which have been modified or incorporated into other products.
- Products purchased or serviced outside the USA.
- Acts of nature, such as but not limited to lightning damage.

## **Limitation of Warranty:**

- The warranty stated above is the only warranty applicable to this product. All other warranties, express or implied (including all implied warranties of merchantability or fitness for a particular purpose) are hereby disclaimed. No verbal or written information given by ATLINKS USA, Inc., its agents, or employees shall create a guaranty or in any way increase the scope of this warranty.
- Repair or replacement as provided under this warranty is the exclusive remedy of the consumer. ATLINKS USA, Inc. shall not be liable for incidental or consequential damages resulting from the use of this product or arising out of any breach of any express or implied warranty on this product. This disclaimer of warranties and limited warranty are governed by the laws of the state of Indiana. Except to the extent prohibited by applicable law, any implied warranty of merchantability or fitness for a particular purpose on this product is limited to the applicable warranty period set forth above.

## **How state law relates to this warranty:**

- This warranty gives you specific legal rights, and you may have other rights which vary from state to state.

## **If you purchased your product outside the USA:**

- This warranty does not apply. Contact your dealer for warranty information.